

# systemer<sup>®</sup>



[Main Catalog](#)

**TANOS**

UNIQUE. PATENTED. UNSURPASSED.  
STACKABLE. LINKABLE. THE systemer<sup>®</sup>  
IS NOT JUST A CASE, IT'S A SYSTEM.

NEW



### Systainer<sup>3</sup>



Even more reliable, with more functions and broader applications – that's Systainer<sup>3</sup>. The third generation stands for even better mobility with a comprehensive mobility concept. Enjoy the advantages you trust with the Systainer<sup>3</sup>: T-Loc central controller, compatible with one another and connectable with all previous systemer<sup>®</sup> generations.



### systemer<sup>®</sup> T-Loc



Just one touch is all you need! Systematically stack individual systemer<sup>®</sup> and lock them with a flick of the wrist – this generation offers innovative T-Loc central controller technology: lock, open, connect. The second generation combines innovation with function and attractive design.



### systemer<sup>®</sup> Classic-Line



Proven top class quality! Our systemer<sup>®</sup> Classic-Line has been accompanying millions of satisfied customers through their everyday work for many years. Of course, it can be combined with all other systemer<sup>®</sup> generations.

## TANOS systainer®

Page 4 - 17

<b>From the past to the future</b>	Page 4 - 5
<b>systainer® applications</b>	Page 6 - 7
<b>More than just a case</b>	Page 8 - 9
<b>Distinctive</b>	Page 10 - 13
<b>systainer® system partners</b>	Page 14 - 15
<b>Systainer<sup>3</sup> connects</b>	Page 16 - 17



## systainer® – CONVINCING ARGUMENTS

Page 18 - 29

<b>Linkable</b>	Page 18 - 19		
<b>Quick &amp; Easy</b>	Page 20 - 21		
<b>Mobile</b>	Page 22 - 23		
<b>Multifunctional</b>	Page 24 - 25		
<b>Reliable</b>	Page 26 - 27		
<b>Versatile</b>	Page 28 - 29		

## systainer® PRODUCT RANGE

Page 32 - 87

# TANOS

systainer®

## FROM THE PAST TO THE FUTURE

TANOS GmbH was founded in 1993 as a subsidiary of TTS Tooltechnic Systems AG & Co. KG. Developing and distributing the systainer® product range is our passion. Secure packaging and clear organization of your work materials and tools, and saving time during transportation – systainer® products provide all of these benefits and more. As the inventors of this unique, patented case system, we have created cases that can be stacked and linked together. Our concept makes a systainer® more than just a case: It's a system!



### ● 1993 systainer® Classic-Line

The systainer® success story begins. Thanks to TANOS systainer® products are available to everyone.



### ● 1995

Cool down:  
The first insulated systainer® makes its way to the customer.

### ● 1 millionth

systainer® sold in 1996.

### ● 2000

Adding big and small options to the family:  
MINI- and MAXI-systainer® Classic-Line.

### ● 2001

Smart sorting:  
With the Drawer-systainer®.

### ● 2008

Intelligent additions:  
systainer® Classic-Line II with lid sort-tray and Rack-systainer®.

### ● 10 millionth

systainer® sold in 2008.

### ● 2010 systainer® T-Loc

Global debut:  
Market launch of the second systainer® generation with unique T-Loc central controller.



2013

Three new products: MIDI-systainer® T-Loc, systainer® Tool-Box and Storage-Box.

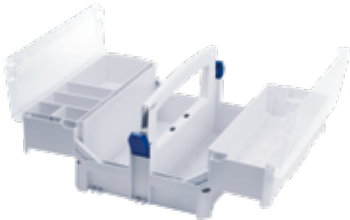

systainer® Storage-Box

2014

Double innovation: Multifunctional table "SYS-MFT" and Drawer "SYS-AZ" for even more comfort.

20 millionth

systainer® sold in 2015.

2015

User-friendly: Introductions of systainer® T-Loc "SYS-Combi" and Sortainer T-Loc "SYS-Sort".



systainer® T-Loc "SYS-Combi II"

2016

systainer® goes live: "SYS-PH" power hub.



2017

The success story continues: MINI-systainer® T-Loc with transparent lid and MINI-systainer® T-Loc III.

25 millionth

systainer® sold in 2018.

2018

TANOS goes USA: The founding of TANOS Inc./USA ensures systainer® is now directly available in the USA as well.

2018

New standard for mobile work: The mobile workshop MW 1000.



2019

# Systainer<sup>3</sup>

**Market launch of the innovative third generation: 100 % mobile, simply practical, better in a system. Cooperation between TANOS, bott and Festool to develop a comprehensive, consistent mobility concept.**



2020

The Systainer<sup>3</sup> system has won numerous design awards for outstanding design quality.

2020

Think big – Systainer<sup>3</sup> XXL with plenty of space and volume!



2021

German Brand Award – Special Mention in the category "Excellent Brands – Tools and Gardening" for outstanding brand work by TANOS.



2021

New Systainer<sup>3</sup> ToolBox – the convertible Version expands the Systainer<sup>3</sup> System.



2022

Everything sorted and organized: Systainer<sup>3</sup> lid compartment M in 3 heights completes the system.



# TANOS

systemer®

## A SMALL SELECTION OF systemer® APPLICATIONS

**TRADES**

**INDUSTRY**

**MEDICAL**

**SALES REPRESENTATIVE EQUIPMENT**

**SPORTS & LEISURE**

**VEHICLE EQUIPMENT**



### A SOLUTION FOR ANY JOB



#### TRADES

Whether you're a do-it-yourselfer or an nationwide trade company, the systemer® is custom-tailored to fulfill your needs and requirements.



#### INDUSTRY

If you want to sell and present your products with a high-quality image, the systemer® is a perfect building block in your brand strategy.



#### MEDICAL

Safety and reliability in transportation and handling are essential in the medical field. A systemer® impresses everywhere and anytime.

## IN USE EVERYWHERE

Your systainer® system offers an endless range of potential applications, in many different industries and sectors. Clearly, systainer® products are a popular choice in trades and industrial applications. But systainer® are also an all-around system built to handle specialized demands and requirements. Innovative developments, accessories, variables, a variety of internal features and easy linking options make the systainer® a smart system for your needs.



### SALES REPRESENTATIVE EQUIPMENT

Put your products in the limelight! systainer® offers individual, customized solutions for product presentation, for even more successful field sales.



### SPORTS & LEISURE

Whether sport fishing or climbing – a systainer® is the perfect choice to store all your sporting equipment in one place.



### VEHICLE EQUIPMENT

Our systainer® can be integrated as part of your vehicle equipment. Mobile and flexible – make your work more effective.

# TANOS

systainer®

## STACKABLE AND LINKABLE

Individual systainer® can be combined, securely stacked, firmly linked and can still be operated individually at the same time.



## TRANSPORT OPTIMIZATION

Standardized dimensions sized for Euro pallets allow boxes to be stacked across the whole surface, saving volume and cash during transportation on pallets – whether in a truck, a warehouse, or a retail store.

## LONG-LASTING DESIGN

If it breaks, fix it!  
All systainer® components, such as lids, handles and catches can be replaced.

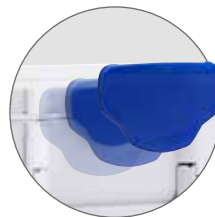

## ABS\* PLASTIC

The best base material combined with a sturdy design offers outstanding structural strength.



\*ABS = Acrylnitril-Butadien-Styrol



## VARIETY OF COLORS

Besides our standard colors, additional colors are available. In addition, colors for the catch, handle and body can be selected individually for custom combinations. No minimum order required.



## DESIGNED IN GERMANY

### DEVELOPED IN HOUSE

Our research and development department with highly qualified engineers and product managers works continuously on the innovative further development of our products with ISO 9001 certification.

### HIGHLY AUTOMATED PRODUCTION

Thanks to standardized processes, we guarantee consistent, high product quality and quality controlling in Germany and Europe.

### ENVIRONMENT & SUSTAINABILITY

The systainer® produced from recyclable ABS ensure more environmentally friendly, recyclable packaging you can use for years, and therefore help to avoid waste.



## MORE THAN JUST A CASE

Today, flexibility on the job is essential. Each and every systainer® is not just a case, but rather part of a cleverly designed system. This allows you to prepare for and react optimally to your work needs. The different possible combinations, and variable interior options for your systainer® are virtually endless. Easily change the arrangement of your systainer® tower to meet your personal needs. All systainer® are stackable and linkable!



### AWARD-WINNING systainer® T-LOC SYSTEM

Multiple awards and consistently positive test results are truly a reflection of the enthusiasm for innovative technologies and the long-lasting, high quality standard of this system.



### STILL THE ORIGINAL

The entire systainer® portfolio is fully protected by a various property rights. The original systainer® is and remains an original. You can rely on that.

# TANOS

systainer®

## HOW TO DESIGN A CUSTOM systainer®

### Step 1: Describe the problem

Do you need a packaging solution for your products, or an organizational, presentation or transportation system? No matter what quantity you need, ask us! We want to be your partner.

### ADDITIONAL SERVICE

#### Step 6: Shipment

We are happy to handle shipping logistics for you, and ensure your systainer® arrive safely.

### ADDITIONAL SERVICE

#### Step 5: Assembly

You send your product and we package it. Upon request, we can attach your custom label and even purchase third party products.



### Step 2: Find the solution

Standard product range, or specially tailored to meet your needs? We are happy to develop the interior features you need, and build a sample if necessary.

### Step 3: Corporate design

Use the systainer® as a product and brand ambassador. We will be happy to advise you and present a variety of options to you.

### Step 4: Market launch

Your custom systainer® is ready for use.

**TIP:** Offer your custom designed systainer®, even without inserts. Color matched and with your own logo!

**TANOS – YOUR PACKAGING SPECIALIST**

### YOUR PACKAGING SOLUTION – THE systainer®

We have already implemented countless customized products in collaboration with our partners. Specialized bottom and lid inserts, deep drawn parts matched to your product or one and two color foam – your customization options know no limits. Ask us, we will be happy to professionally handle your requirements.



## DISTINCTIVE

Each and every systainer® is important to us. Whether you choose a standard version with available system components or a custom special design tailored to your needs. We support you, from initial idea to delivery. Design, color, interior features, formats, or applications: we look forward to presenting the countless possibilities of the systainer® system to you. Benefit from the case system already used by numerous well-known manufacturers.

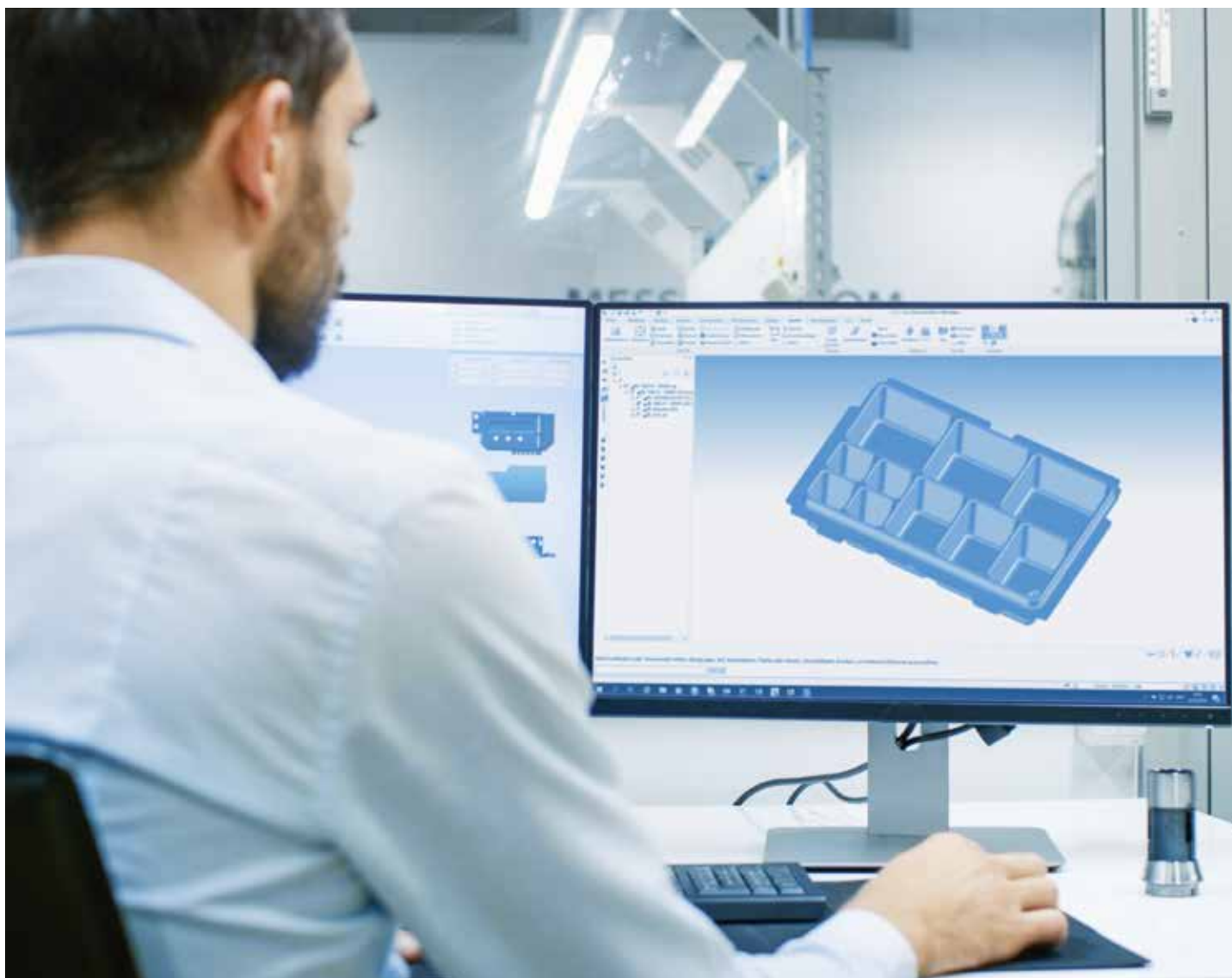

### THEFT-TAG – BETTER SAFE THAN SORRY

Benefit for manufacturers and dealers: the “Theft Tag” closure is integrated directly on the Systainer<sup>3</sup>. All-around theft protection: everything safe and enclosed. No more illicit removals of products. Also a major advantage in the medical sector, e.g. for sealing medical examination materials.



# TANOS

systainer®

## CORPORATE DESIGN

No brand strategy without branding. Whether you want to add your company logo or your slogan – even with small quantities, you can print the body, lid and catches with multiple colors. Thanks to the modular design, you can assemble your own systainer® from our extensive color palette. Brand recognition guaranteed!

## LABELING

Simple and practical labeling of your systainer® with labeling sets for card inserts.



## CONFIGURATION ONLINE

Simple and innovative system to design your custom systainer® in just a few steps. Design and equip your custom systainer® now at [www.tanos.de](http://www.tanos.de).



Lid handle



Lid



Catch body



Pin



Catch cover



Body

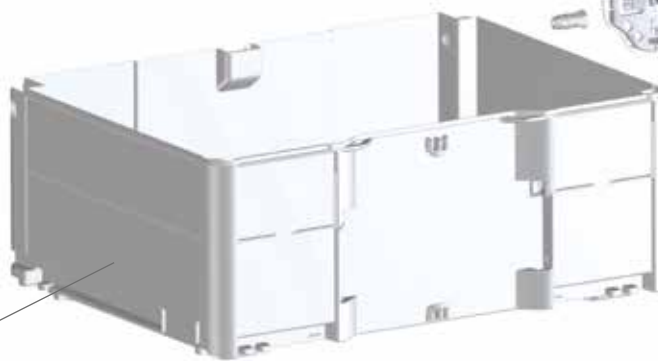

Pull-out aid  
( $\geq 237$ )



Front handle  
( $\leq 187$ )



## EXTRA TIPS

## PERFECT CUSTOMIZATION

At larger order quantities, we can also emboss your product or company brand directly to the right and left of the edge of the lid or on the lid of your systainer®.





## COLOR PALETTE





Do you prefer bright and colorful or discreet and reserved? We offer our timeless standard design in light grey with signal blue catch or all anthracite at no additional charge.

Numerous additional RAL color shades are available ex works. Do you need a custom color? No problem, we will be happy to advise you!

## STANDARD COLORS

	RAL 7035, light grey
	HKS 43 K, signal blue
	RAL 7016, anthracite

## ADDITIONAL COLORS

	RAL 9004, black		RAL 3002, carmine red		RAL 6001, emerald green
	RAL 1007, daffodil yellow		RAL 5015, sky blue		HKS 54 K, signal green
	RAL 2011, deep orange		RAL 5003, sapphire blue		RAL 9016, white

## IT'S WHAT'S INSIDE THAT COUNTS

Ask us! We will provide you with professional support and advising, no matter your idea or requirement. Whether you plan to use the systainer® as packaging or to present your products, to transport sensitive goods or to equip your workshops or production warehouses in an organized way – we will construct, develop and design your custom systainer® solution to precisely meet your needs.

### Standard product range



### Special design



## YOUR PRODUCT AMBASSADOR

You can even use the interior areas as an advertising surface! Use the systainer® lid for important product information or user instructions.



# TANOS

systainer®

## systainer® SYSTEM PARTNERS: A SMALL EXCERPT



### i

## IMPRESSIVE NUMBERS

### 55 DIFFERENT systainer® VARIATIONS

Innovation and creativity are the drivers behind everything we do. We don't just want to fulfill your requirements; we also want to meet your needs.

### AN ENDLESS RANGE OF COMBINATIONS

systainer® does what you want! Virtually unlimited possibilities allow for perfectly tailored customization.

## EVERYTHING BUILDS ON THE **systainer®**

As the manufacturer of the most popular linkable case system on the market, we believe in the power of experience: To get where you're going, you've got to know where you've been! The success of the **systainer®** proves us, and you, right. We'd like to say a huge thank you to our customers and partners! Over 30 million **systainer®** sold have made our system what it is today. You can build on the **systainer®**, since 1993. It's here today, and it will be here tomorrow as well. We promise.



### **MORE THAN 30 MILLION** **systainer®**

A big thank you to our customers and partners! The **systainer®** is conquering the world and we are delighted with more than 30 million sold **systainer®**.

### **3 PRODUCT LINES, 1 SYSTEM**

**Systainer<sup>3</sup>**, **systainer® T-Loc**, **systainer® Classic-Line**: Unique, clever, stackable, and linkable. Together, on top of one another, and across brands.

**MILLIONS**  
**OF SATISFIED**  
**USERS SPEAK FOR**  
**THEMSELVES.**

**systainer**<sup>®</sup>  
The new generation

## Systainer<sup>3</sup> CONNECTS

Custom-tailored vehicle integration for simple and secure transportation. With a uniform packaging and transportation system, optimally integrated into a vehicle equipment, Systainer<sup>3</sup> keeps everything clearly organized and safely stowed, from your stationary workshop to your mobile work site.

TANOS, bott and Festool have worked together to develop a mobility system that integrates perfectly with the bott vario3 in-vehicle equipment. Now, you can take the order and the simple handling of the systainer<sup>®</sup> system, safely with you in your vehicle. You benefit from a well thought-out mobility concept and an even more professional image toward your customers.





# Systainer<sup>3</sup> CONNECTS SOLUTIONS

## LINKABLE

"With systainer<sup>®</sup>, I've got a friend for life."

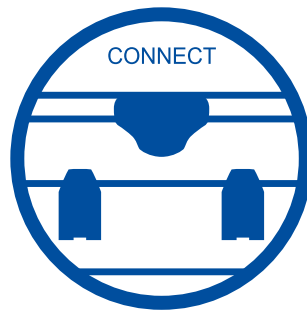

## VERSATILE

"With systainer<sup>®</sup>, I'm working with a system."

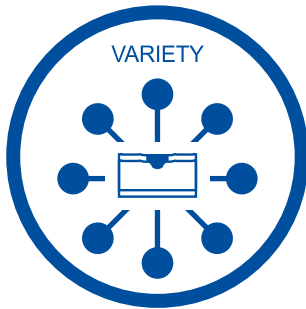

## QUICK & EASY

"The systainer<sup>®</sup> makes my everyday work easier."



## Trusted

T-Loc central controller

## Secure

Theft-tag catch system



## RELIABLE

"With systainer<sup>®</sup>, I've got a reliable partner."



## MULTIFUNCTIONAL

"The systainer<sup>®</sup> does what I want."



## MOBILE

"The systainer<sup>®</sup> is a perfect fit for 100% mobility."

**systemer**<sup>®</sup>  
The new generation

WITH SYSTAINER  
I'VE GOT A FRIEND  
FOR LIFE

**Systainer<sup>3</sup>**

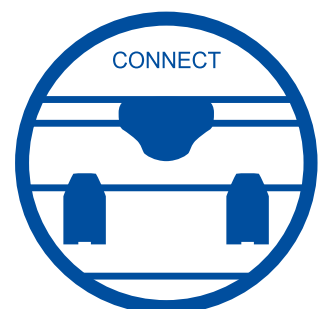

## LINKABLE

Stackable and linkable – our market-leading, patented case system helps millions of users with their everyday work. systainer® impress in everyday use. They link together quickly, saving lots of time and unnecessary walking. systainer® towers can be carried with a single handle, offering excellent convenience and mobility. Our new Systainer<sup>3</sup> product line impresses with the ability to link cases of different generations. They can be combined with existing systainer® product lines as well as with systainer® system partners.



### Stackable

Link systainer® to create a systainer® tower with a simple turn.

### Compatibility

All systainer® can be combined with one another.



### Versatile combinations

#### systainer® ToolBox

The perfect ToolBox – available in four sizes.



#### systainer® Storage-Box

Keep your perspective – clear, easy access storage.



#### systainer® T-Loc "SYS-Combi"

systainer® with an integrated drawer for even better organization.



**systemer**<sup>®</sup>  
The new generation

THE SYSTAINER  
MAKES MY EVERYDAY  
WORK EASIER

**Systainer<sup>3</sup>**



## QUICK & EASY

Easy to operate and convenient in everyday work. Close, open and link using trusted, patented and unique T-Loc central controller. Easily access contents, connect or remove systainer® with just one hand and just one turn. In addition, transportation is easier than ever before with the Systainer<sup>3</sup>. Whether upright, individually or as a linked tower.



### Open while linked

Access contents with just one motion, without breaking the links between cases.



### One hand operation

Close, open and link with just one turn.

### Automated

Lid closes easier thanks to our optimized design.



### Pull-out aid

Above size 237, a pull-out aid makes it easier to remove the case from a shelf or vehicle.



### Front handle

Systainer<sup>3</sup> M + L 112-187 and Systainer<sup>3</sup> Organizer M + L can also be carried upright thanks to their front handles and well thought-out design.



### Easy transportation

Easily transport cases individually or as a tower using the front handle, or the lid handle. Move faster and enjoy better convenience with the Systainer<sup>3</sup>.



### TIP: Innovative labeling

Know what's inside! Two slots for custom labeling. Design online at [www.tanos.de](http://www.tanos.de)



**systainer**<sup>®</sup>  
The new generation

THE SYSTAINER  
OFFERS A PERFECT FIT  
FOR 100% MOBILITY

**Systainer<sup>3</sup>**



## MOBILE

Use all the advantages of the systainer® system and benefit from the additional mobility offered by the third generation, which was a specific focus during development. It makes everyday work even easier for professional users, from the workshop to the construction site. Save space, time and strengthen your reputation with the Systainer<sup>3</sup>.



### Perfect use of space

systainer® use standardized grid dimensions for optimal use of space in the vehicle, meaning they fit into many common vehicle equipment systems.

### Access made easy

With the pull-out aid and optimized lid handle, the Systainer<sup>3</sup> is easier to remove and use quickly.



### Even simpler transportation

The new generation has redefined a combination of convenience and function. The Systainer<sup>3</sup> can be stowed easily and quickly, secure for transportation without any additional rail elements in bott vario3 van racking.



**systainer**<sup>®</sup>  
The new generation

THE SYSTAINER  
DOES WHAT  
I WANT



**Systainer<sup>3</sup>**





## MULTIFUNCTIONAL

The variable features offered for systainer® are the alpha and omega for meeting any requirement. With accessories, lid and bottom inserts, organizing and sorting systems and a larger selection of heights and widths, the new generation Systainer<sup>3</sup> offers an almost limitless range of variations for any need. Clear and simple, with optimal usage of space. The systainer® stands up to any challenge; there's always a systainer® solution.



**For fans of structure:**  
Small parts sorting for professionals. With Systainer<sup>3</sup> Organizer and its insert boxes, every small part has its place and is clearly sorted.



### Systainer<sup>3</sup> Organizer in two sizes

In addition to the M 89 size, the L 89 variation is available for even broader sorting options.

#### Storage

Molded compartments for your tools, with user-friendly packaging. From universal to specialized inserts, the systainer® has the right option for your specific needs.



#### Space saver

Optimal use of available space.



#### Clearly organized

Clearly organized storage and availability for materials you use every day. Everything at a single glance!



#### Big, bigger, Systainer<sup>3</sup>

With XXS-XXL sizes, the Systainer<sup>3</sup> generation offers a large spectrum of heights and widths. The right size for every requirement.



**systainer**<sup>®</sup>  
The new generation

WITH SYSTAINER  
I HAVE A  
RELIABLE PARTNER

**Systainer**<sup>3</sup>



## RELIABLE

All Systainer<sup>3</sup> offer outstanding strength thanks to their ABS\* base material, combined with an innovative and stabilizing design structure. Your products are always safely stored, reliably packaged, and ready for transportation at any time with a Systainer<sup>3</sup>. With the Systainer<sup>3</sup> quality case system, you have a reliable partner for your everyday work.



### HARD SHELL

Perfect combination: excellent ABS\* material and a stabilizing design structure with the additional lid hinge and optimized "base cross" mean the Systainer<sup>3</sup> offers a highly rugged design.



### SOFT CORE

A Systainer<sup>3</sup> doesn't bend easily. Sensitive contents are well protected in the Systainer<sup>3</sup>.

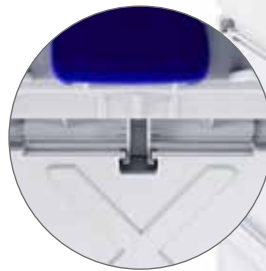

### Impact protection

Padding combination for maximum interior dampening. Even highly breakable goods are fully protected against damage.

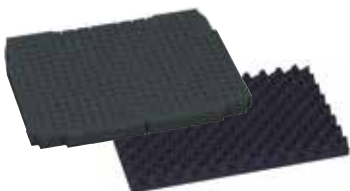

### Vibration-protected transportation

Every part remains in its place. Perfect-fit lid inserts ensure a solid, secure closure.



MINI-systainer®

### Did you know?

systainer® is often used in the medical field.



**systainer**<sup>®</sup>  
The new generation

WITH SYSTAINER  
I'M WORKING  
WITH A SYSTEM

**Systainer<sup>3</sup>**

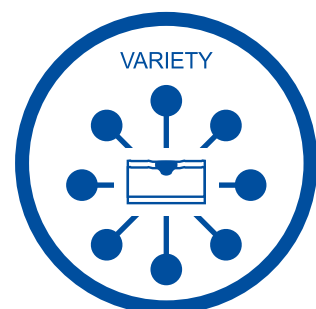

## VERSATILE

It's not just a case, it's a system! The TANOS portfolio includes not only the innovative systainer® case system, but also an extensive range of practical accessories. From stationary work to transportation to the job site and mobile work directly on site, TANOS offers a wide range of solutions to work even better with a system. No matter how unusual your needs might be, you can rely on our creative product solutions and continuously growing range of innovations.



### Stationary work

Perfect storage and work in the workshop with systainer®.

Product selection



Systainer³ BASE-Wall/base support



Drawer "SYS-AZ"

### Transportation

Secure your load and protect your health with our mobile accessories range.

Product selection



Anti-slip mats



Systainer³ CART „SYS-RB“



Transport trolley "SYS-ROLL"

### Mobile work

Innovative systainer® solutions that allow you to work efficiently, anytime and anywhere.

Product selection



Mobile workshop MW 1000



Multifunctional table "SYS-MFT"

... and much more.

## FLEXIBLE AND MOBILE ON THE GO

As the manufacturer behind the systainer® connectable storage system – which has sold millions of units to date – we always have our eye on the latest trends. Today, flexibility and mobility are central facets of everyday work for most tradespeople. Our mobile workshop offers the flexibility you need, ensuring it is ready to use for any application. Compact, comfortable, and with maximum portability, the mobile workshop can be set up anywhere you need it. That's efficiency that pays off!



### SAFE

- Safely attach work surface to the cart for transportation using the integrated strap



### MULTIFUNCTIONAL

- Flexible clamping mounts on all sides
- Can be connected to additional work tables (TSB/1-MW 1000) on all sides
- Even, stable and consistent work surface



### EASY TO USE

- Simple to handle and transport, even on your own



### STURDY

- Adjustable feet
- Cart stands on four feet – not on the rollers

**Robust:** Trolley and wheels easily handle uneven surfaces



**Independent:** The mobile workshop is ready to use whenever and wherever you need it



**Sturdy:** The stable construction ensures optimal working conditions anywhere



**Ready to go!** Quick storage and everything in place for the next job site



**FLEXIBLE**

- Integrated MDF work surface for safely attaching additional systainer® (suitable for all systainer® generations.)



**ORGANIZED**

- Stable drawer (SYS-AZ-MW 1000)
- Perfect fit for mounting systainer® with base area of W 396 x D 296 mm
- Custom fitting with drawers
- Variable height adjustment without tools



**RELIABLE**

- T-Loc catch to attach the systainer® to the mobile workshop



**PRACTICAL**

- Easily load into a vehicle with sliding surfaces on the handle



**INTUITIVE**

- Three different position settings – locks automatically



**STURDY**

- Large rubber wheels, 200 mm diameter for easily climbing stairs, without gravel residue or visible wear to floors

**CLEVER**

- Storage for MINI-systainer® T-Loc I in the base tray
- Additional drawer can be retrofitted (SYS-AZ art. no. 80101664)



# systemer®

Product range





# OUR PRODUCT RANGE

## EMPTY-systainer®, SETS AND INSERTS

systainer® dimensions



Page 34 - 35

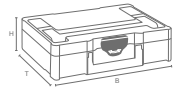

Systainer<sup>3</sup> M



Page 36 - 47



Systainer<sup>3</sup> L



Page 48 - 53



Systainer<sup>3</sup> XXL



Page 54 - 55



Systainer<sup>3</sup> Organizer



Page 56 - 59



Systainer<sup>3</sup> ToolBox



Page 60 - 61



Systainer<sup>3</sup> lid compartment M



Page 62 - 63



SYS-Combi, SYS-Sort  
Rack-, Drawer-systainer®



Page 64 - 69



MINI-systainer®



Page 70 - 73



systainer® Storage-Box



Page 74 - 75



## systainer® ADDITIONS AND ACCESSORIES

Labelling

Page 76



Safety, Anti-slip mats, Systainer<sup>3</sup> XXS

Page 77

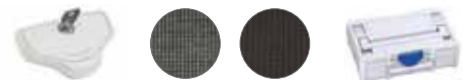

Mobile work

Page 78 - 81



Stationary work

Page 82 - 83



Spares

Page 84 - 87



# SYSTEMER<sup>®</sup> DIMENSIONS

Sizes from XXS to XXL! Well-conceived and perfectly matched dimensions make it easy for you to adapt our systemer<sup>®</sup> optimally to your requirements to save space.

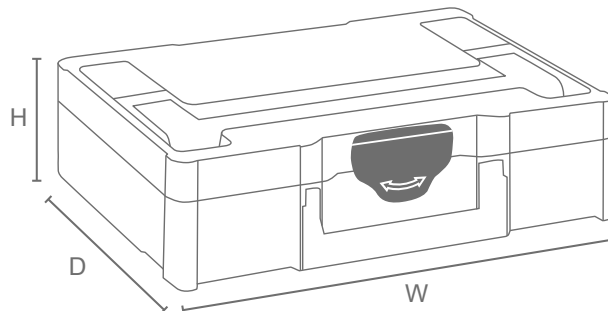

## Systemer<sup>3</sup>



	Outside in mm	Inside in mm	Weight	Inner volume	Pallet Pcs. / H.
<b>Systemer<sup>3</sup> M 112</b> 1)	H* 105 x W 396 x D 296	H 71 x W 389.5 x D 275	1.40 kg	7.7 l	128 / 183.7 cm
<b>Systemer<sup>3</sup> M 137</b> 2)	H* 130 x W 396 x D 296	H 96 x W 389.5 x D 275	1.50 kg	10.4 l	104 / 184.7 cm
<b>Systemer<sup>3</sup> M 187</b> 3)	H* 180 x W 396 x D 296	H 146 x W 389.7 x D 275.2	1.69 kg	15.9 l	72 / 177.7 cm
<b>Systemer<sup>3</sup> M 237</b> 4)	H* 230 x W 396 x D 296	H 196 x W 389.7 x D 275.2	1.89 kg	21.4 l	56 / 176.7 cm
<b>Systemer<sup>3</sup> M 337</b> 5)	H* 330 x W 396 x D 296	H 296 x W 389.7 x D 275.2	2.35 kg	32.4 l	40 / 180.7 cm
<b>Systemer<sup>3</sup> M 437</b> 6)	H* 430 x W 396 x D 296	H 394 x W 389.7 x D 275.2	2.89 kg	43.1 l	32 / 187.7 cm



	Outside in mm	Inside in mm	Weight	Inner volume	Pallet Pcs. / H.
<b>Systemer<sup>3</sup> L 137</b> 7)	H* 130 x W 508 x D 296	H 94 x W 501.5 x D 275.2	1.92 kg	13.2 l	52 / 184.7 cm
<b>Systemer<sup>3</sup> L 187</b> 8)	H* 180 x W 508 x D 296	H 144 x W 501.7 x D 275.2	2.14 kg	20.2 l	36 / 177.7 cm
<b>Systemer<sup>3</sup> L 237</b> 9)	H* 230 x W 508 x D 296	H 194 x W 501.7 x D 275.2	2.38 kg	27.4 l	28 / 176.7 cm



	Outside in mm	Inside in mm	Weight	Inner volume	Pallet Pcs. / H.
<b>Systemer<sup>3</sup> XXL 237</b> 10)	H* 230 x W 792 x D 296	H 188 x W 786.5 x D 279.1	3.64 kg	42.3 l	28 / 176.7 cm
<b>Systemer<sup>3</sup> XXL 337</b> 11)	H* 330 x W 792 x D 296	H 288 x W 786.1 x D 279.1	4.33 kg	64.2 l	20 / 180.7 cm



	Outside in mm	Inside in mm	Weight	Inner volume	Pallet Pcs. / H.
<b>Systemer<sup>3</sup> Organizer M 89</b> 12)	H* 82 x W 396 x D 296	H 60 x W 389.5 x D 246.2	1.60 kg	7.4 l	160 / 183.7 cm
<b>Systemer<sup>3</sup> Organizer L 89</b> 13)	H* 82 x W 508 x D 296	H 60 x W 501.5 x D 278.5	1.99 kg	9.7 l	80 / 183.7 cm



	Outside in mm	Inside in mm	Weight	Inner volume	Pallet Pcs. / H.
<b>Systemer<sup>3</sup> ToolBox M 137</b> 14)	H* 130 x W 396 x D 296	H 122 x W 357.8 x D 221	1.30 kg	10.4 l	104 / 184.7 cm
<b>Systemer<sup>3</sup> ToolBox M 237</b> 15)	H* 230 x W 396 x D 296	H 222 x W 357.8 x D 221	1.70 kg	21.4 l	56 / 176.7 cm
<b>Systemer<sup>3</sup> ToolBox L 137</b> 16)	H* 130 x W 508 x D 296	H 120 x W 461.1 x D 221	1.90 kg	13.2 l	52 / 184.7 cm
<b>Systemer<sup>3</sup> ToolBox L 237</b> 17)	H* 230 x W 508 x D 296	H 220 x W 461.1 x D 221	2.40 kg	27.4 l	28 / 176.7 cm



	Outside in mm	Inside in mm	Weight	Inner Volume	Pallet Pcs. / H.
<b>Systainer<sup>3</sup> lid compartment M 137</b> 18)	H* 130 x W 396 x D 296	H 96 x W 389.5 x D 275	1,70 kg	10,4 l	104 / 184,7 cm
<b>Systainer<sup>3</sup> lid compartment M 187</b> 19)	H* 180 x W 396 x D 296	H 146 x W 389.7 x D 275,2	1,90 kg	15,9 l	72 / 177,7 cm
<b>Systainer<sup>3</sup> lid compartment M 237</b> 20)	H* 230 x W 396 x D 296	H 196 x W 389.7 x D 275,2	2,10 kg	21,4 l	56 / 176,7 cm



## T-Loc\*\*



	Outside in mm	Inside in mm	Weight	Pallet Pcs. / H.
<b>systainer<sup>®</sup> T-Loc „SYS-Combi II“</b> 1)	H* 263 x W 396 x D 296	H 127.5 x W 383 x D 267	3.20 kg	48 / 173 cm
<b>Drawer</b>	-	H 69 x W 350 x D 255	-	-
<b>systainer<sup>®</sup> T-Loc „SYS-Combi III“</b> 2)	H* 315 x W 396 x D 296	H 180 x W 383 x D 266	3.50 kg	40 / 173 cm
<b>Drawer</b>	-	H 69 x W 350 x D 255	-	-
<b>Sortainer T-Loc „SYS-Sort IV/3“</b> 3)	H* 315 x W 396 x D 296	-	5.94 kg	40 / 173 cm
<b>Drawer</b>	-	H 69 x W 350 x D 255	-	-



	Outside in mm	Inside in mm	Weight	Pallet Pcs. / H.
<b>MINI-systainer<sup>®</sup> T-Loc I</b> 4)	H* 71 x W 265 x D 171	H 53 x W 254.5 x D 154.5	0.43 kg	400 / 192 cm
<b>MINI-systainer<sup>®</sup> T-Loc I</b> with transparent lid 5)	H* 71 x W 265 x D 171	H 53 x W 254.5 x D 154.5	0.43 kg	400 / 192 cm
<b>MINI-systainer<sup>®</sup> T-Loc III</b> 6)	H* 142 x W 265 x D 171	H 124 x W 254.5 x D 154.5	0.60 kg	192 / 198 cm



## Classic-Line\*\*



	Outside in mm	Inside in mm	Weight	Pallet Pcs. / H.
<b>Drawer-systainer<sup>®</sup> III</b> 1)	H* 210 x W 400 x D 300	-	4.00 kg	64 / 183 cm
<b>Rack-systainer<sup>®</sup> IV</b> 2)	H* 315 x W 400 x D 300	-	6.80 kg	40 / 173 cm



## T-Loc / Classic-Line\*\*



	Outside in mm	Inside in mm	Weight	Pallet Pcs. / H.
<b>systainer<sup>®</sup> Storage-Box</b> 1)	H* 160 x W 396 x D 296 Height with handle*: 233	-	2.50 kg	88 / 196 cm

\*The outside dimensions are measured without feet: Systainer<sup>3</sup> M, L, XXL, Systainer<sup>3</sup> Organizer M + L, Systainer<sup>3</sup> lid compartment M, Systainer<sup>3</sup> ToolBox M + L, systainer<sup>®</sup> T-Loc „SYS-Combi II + III“, Sortainer T-Loc „SYS-Sort IV / 3“, systainer<sup>®</sup> Storage-Box: H +7 mm, MINI-systainer<sup>®</sup> T-Loc I + III: H +4.7 mm, MAXI-systainer<sup>®</sup>, Drawer-systainer<sup>®</sup> III and Rack-systainer<sup>®</sup> IV: +5 mm \*\* Not equipped with an integrated vehicle mount for both vario3



## Systainer<sup>3</sup> M 112

Small and functional! Thanks to its low height, for example, it is an excellent way to store abrasive material. The Systainer<sup>3</sup> M 112 can be conveniently transported upright with its front handle.

### Systainer<sup>3</sup> M 112

- Light grey art n° 83000001
- Anthracite art n° 83000018

## DIMENSIONS

Outside in mm	Inside in mm	Weight	Carrying capacity	Inner volume	Pallet Pcs./H.
H* 105 x W 396 x D 296	H 71 x W 389.5 x D 275	1.40 kg	20 kg	7.7 l	128 / 183.7 cm

\*The outside dimensions are measured without feet: H + 7 mm

## COLOR

	Standard colors	Additional colors	
Body with lid	1)  3)	4)  5)  6)  7)  8)  9)  10)	
Lid handle	1)  3)	4)  5)  6)  7)  8)  9)  10)  11)  12)	
Catch	2)  3)	1)  4)  5)  6)  7)  8)  9)  10)  11)  12)	
1) RAL 7035, light grey	4) RAL 9004, black	7) RAL 3002, carmine red	10) RAL 6001, emerald green
2) HKS 43 K, signal blue	5) RAL 1007, daffodil yellow	8) RAL 5015, sky blue	11) HKS 54 K, signal green
3) RAL 7016, anthracite	6) RAL 2011, deep orange	9) RAL 5003, sapphire blue	12) RAL 9016, white

## Systainer<sup>3</sup> M 112 SETS



### Universal-Systainer<sup>3</sup> M 112

- Light grey art n° 83500009
- Anthracite art n° 83500010
- With lid insert, EPP, 5 mm and universal insert with 10 compartments



### Abrasive material Systainer<sup>3</sup> M 112

- Light grey art n° 83500013
- Anthracite art n° 83500014
- With insert for abrasives  
Ø 125 mm, 80 x 133 mm and  
Delta 100 x 150 mm

## LID INSERTS



**Lid insert, EPP, 5 mm**  
• Art n° 83000044



**Lid foam, vaulted**  
• Art n° 83000035  
(Industry customers\*)  
• Art n° 83570006  
(Dealers/end users\*\*)



**Office lid**  
• Art n° 83500069

## BOTTOM INSERTS



**Base foam soft, 25 mm**  
• Art n° 83000036  
(Industry customers\*)  
• Art n° 83570007  
(Dealers/end users\*\*)



**Pick & pluck foam rigid, 25 mm**  
• Art n° 83000038  
(Industry customers\*)  
• Art n° 83570009  
(Dealers/end users\*\*)

Perforated cubes, 15 x 15 mm,  
for quarrying out



**Base foam with cross cut-out**  
• Art n° 83000037  
(Industry customers\*)  
• Art n° 83570008  
(Dealers/end users\*\*)



**Universal insert with  
10 compartments**  
• Art n° 83000052



**Insert for abrasives Ø 125 mm,  
80 x 133 mm and  
Delta 100 x 150 mm**  
• Art n° 83000056



## Systainer<sup>3</sup> M 137

Handy and mobile! The Systainer<sup>3</sup> M 137 can not only be perfectly integrated into a vehicle equipment, it is also easy to remove and transport using the front handle.

### Systainer<sup>3</sup> M 137

- Light grey art n° 83000002
- Anthracite art n° 83000019

## DIMENSIONS

Outside in mm	Inside in mm	Weight	Carrying capacity	Inner volume	Pallet Pcs./H.
H* 130 x W 396 x D 296	H 96 x W 389.5 x D 275	1.50 kg	20 kg	10.4 l	104 / 184.7 cm

\*The outside dimensions are measured without feet: H + 7 mm

## COLORS

	Standard colors	Additional colors	
Body with lid	1)  3)	4)  5)  6)  7)  8)  9)  10)	
Lid handle	1)  3)	4)  5)  6)  7)  8)  9)  10)  11)  12)	
Catch	2)  3)	1)  4)  5)  6)  7)  8)  9)  10)  11)  12)	
1) RAL 7035, light grey	4) RAL 9004, black	7) RAL 3002, carmine red	10) RAL 6001, emerald green
2) HKS 43 K, signal blue	5) RAL 1007, daffodil yellow	8) RAL 5015, sky blue	11) HKS 54 K, signal green
3) RAL 7016, anthracite	6) RAL 2011, deep orange	9) RAL 5003, sapphire blue	12) RAL 9016, white

## Systainer<sup>3</sup> M 137 SETS



### Padded-Systainer<sup>3</sup> M 137

- Light grey art n° 83500015
- Anthracite art n° 83500016
- With base foam soft, 25 mm, base pick & pluck foam rigid, 25 mm and lid foam, vaulted



### Cordless drill Systainer<sup>3</sup> M 137

- Light grey art n° 83500011
- Anthracite art n° 83500012
- With insert for cordless drill and lid foam, vaulted

## LID INSERTS



**Lid insert, EPP, 5 mm**  
• Art n° 83000044



**Lid foam, vaulted**  
• Art n° 83000035  
(Industry customers\*)  
• Art n° 83570006  
(Dealers/end users\*\*)



**Office lid**  
• Art n° 83500069

## BOTTOM INSERTS



**Base foam soft, 25 mm**  
• Art n° 83000036  
(Industry customers\*)  
• Art n° 83570007  
(Dealers/end users\*\*)



**Pick & pluck foam rigid, 25 mm**  
• Art n° 83000038  
(Industry customers\*)  
• Art n° 83570009  
(Dealers/end users\*\*)

Perforated cubes, 15 x 15 mm,  
for quarrying out



**Base foam with cross cut-out**  
• Art n° 83000037  
(Industry customers\*)  
• Art n° 83570008  
(Dealers/end users\*\*)



**Insert for cordless drill**  
• Art n° 83000053



## Systainer<sup>3</sup> M 187

With its compact dimensions, the Systainer<sup>3</sup> M 187 adapts to your individual equipment needs. The Systainer<sup>3</sup> M 187 is especially well suited for power tools or office materials. Upright carrying option included with the front handle.

### Systainer<sup>3</sup> M 187

- Light grey art n° 83000003
- Anthracite art n° 83000020

## DIMENSIONS

Outside in mm	Inside in mm	Weight	Carrying capacity	Inner volume	Pallet Pcs./H.
H* 180 x W 396 x D 296	H 146 x W 389.7 x D 275.2	1.69 kg	20 kg	15.9 l	72 / 177.7 cm

\*The outside dimensions are measured without feet: H + 7 mm

## COLORS

	Standard colors	Additional colors	
Body with lid	1)  3)	4)  5)  6)  7)  8)  9)  10)	
Lid handle	1)  3)	4)  5)  6)  7)  8)  9)  10)  11)  12)	
Catch	2)  3)	1)  4)  5)  6)  7)  8)  9)  10)  11)  12)	
1) RAL 7035, light grey	4) RAL 9004, black	7) RAL 3002, carmine red	10) RAL 6001, emerald green
2) HKS 43 K, signal blue	5) RAL 1007, daffodil yellow	8) RAL 5015, sky blue	11) HKS 54 K, signal green
3) RAL 7016, anthracite	6) RAL 2011, deep orange	9) RAL 5003, sapphire blue	12) RAL 9016, white

## Systainer<sup>3</sup> M 187 SETS



### Oscillator-Systainer<sup>3</sup> M 187

- Light grey art n° 83500017
- Anthracite art n° 83500018
- With insert for oscillator and lid foam, vaulted



### Angle grinder Systainer<sup>3</sup> M 187

- Light grey art n° 83500019
- Anthracite art n° 83500020
- With insert for angle grinders Ø 125 mm and lid foam, vaulted



### Office-Systainer<sup>3</sup> M 187

- Light grey art n° 83500021
- Anthracite art n° 83500022
- With office lid and full padding



## LID INSERTS



**Lid insert, EPP, 5 mm**  
• Art n° 83000044



**Lid foam, vaulted**  
• Art n° 83000035  
(Industry customers\*)  
• Art n° 83570006  
(Dealers/end users\*\*)



**Office lid**  
• Art n° 83500069

## BOTTOM INSERTS



**Base foam soft, 25 mm**  
• Art n° 83000036  
(Industry customers\*)  
• Art n° 83570007  
(Dealers/end users\*\*)



**Pick & pluck foam rigid, 25 mm**  
• Art n° 83000038  
(Industry customers\*)  
• Art n° 83570009  
(Dealers/end users\*\*)

Perforated cubes, 15 x 15 mm,  
for quarrying out



**Base foam with cross cut-out**  
• Art n° 83000037  
(Industry customers\*)  
• Art n° 83570008  
(Dealers/end users\*\*)



**Full padding**  
• Art n° 83000039



**Insert for angle grinder**  
Ø 125 mm  
• Art n° 83000054



**Insert for oscillator**  
• Art n° 83000055



**Foam for fixation for insert  
for oscillator**  
• Art n° 83500077



## Systainer<sup>3</sup> M 237

Optimal storage for tools or insulation for sensitive contents: that's the Systainer<sup>3</sup> M 237. The integrated pull-out aid makes it easier to remove the case from a shelf or vehicle.

### Systainer<sup>3</sup> M 237

- Light grey art n° 83000004
- Anthracite art n° 83000021

## DIMENSIONS

Outside in mm	Inside in mm	Weight	Carrying capacity	Inner volume	Pallet Pcs./H.
H* 230 x W 396 x D 296	H 196 x W 389.7 x D 275.2	1.89 kg	20 kg	21.4 l	56 / 176.7 cm

\*The outside dimensions are measured without feet: H + 7 mm

## COLORS

	Standard colors	Additional colors	
Body with lid	1)  3)	4)  5)  6)  7)  8)  9)  10)	
Lid handle	1)  3)	4)  5)  6)  7)  8)  9)  10)  11)  12)	
Catch	2)  3)	1)  4)  5)  6)  7)  8)  9)  10)  11)  12)	
1) RAL 7035, light grey	4) RAL 9004, black	7) RAL 3002, carmine red	10) RAL 6001, emerald green
2) HKS 43 K, signal blue	5) RAL 1007, daffodil yellow	8) RAL 5015, sky blue	11) HKS 54 K, signal green
3) RAL 7016, anthracite	6) RAL 2011, deep orange	9) RAL 5003, sapphire blue	12) RAL 9016, white

## Systainer<sup>3</sup> M 237 SETS



### Abrasive material Systainer<sup>3</sup> M 237

- Light grey art n° 83500023
- Anthracite art n° 83500024
- With insert for abrasives  
Ø 150 mm



### Insulated Systainer<sup>3</sup> M 237 EPP

- Light grey art n° 83500037
- Anthracite art n° 83500038
- With EPP insulating insert and insulating lid

## LID INSERTS



**Lid insert, EPP, 5 mm**  
• Art n° 83000044



**Lid foam, vaulted**  
• Art n° 83000035  
(Industry customers\*)  
• Art n° 83570006  
(Dealers/end users\*\*)



**Office lid**  
• Art n° 83500069

## BOTTOM INSERTS



**Base foam soft, 25 mm**  
• Art n° 83000036  
(Industry customers\*)  
• Art n° 83570007  
(Dealers/end users\*\*)



**Pick & pluck foam rigid, 25 mm**  
• Art n° 83000038  
(Industry customers\*)  
• Art n° 83570009  
(Dealers/end users\*\*)

Perforated cubes, 15 x 15 mm,  
for quarrying out



**Base foam with cross cut-out**  
• Art n° 83000037  
(Industry customers\*)  
• Art n° 83570008  
(Dealers/end users\*\*)



**Insert for abrasives**  
Ø 150 mm  
• Art n° 83000057



**Divider for Insulated Systainer³**  
• Art n° 83500066  
• Set of 2



**Set of 3 dividers**  
• Art n° 83500054



## Systainer<sup>3</sup> M 337

Flying high with the Systainer<sup>3</sup> M 337. With its impressive height, it offers lots of inside space for hand tools and tall materials. It is optimally suited for insulating cartridges, spray cans and sensitive contents.

### Systainer<sup>3</sup> M 337

- Light grey art n° 83000005
- Anthracite art n° 83000022

## DIMENSIONS

Outside in mm	Inside in mm	Weight	Carrying capacity	Inner volume	Pallet Pcs./H.
H* 330 x W 396 x D 296	H 296 x W 389.7 x D 275.2	2.35 kg	20 kg	32.4 l	40 / 180.7 cm

\*The outside dimensions are measured without feet: H + 7 mm

## COLORS

	Standard colors	Additional colors
Body with lid	1)  3)	4)  5)  6)  7)  8)  9)  10)
Lid handle	1)  3)	4)  5)  6)  7)  8)  9)  10)  11)  12)
Catch	2)  3)	1)  4)  5)  6)  7)  8)  9)  10)  11)  12)
	1) RAL 7035, light grey 2) HKS 43 K, signal blue 3) RAL 7016, anthracite	4) RAL 9004, black 5) RAL 1007, daffodil yellow 6) RAL 2011, deep orange 7) RAL 3002, carmine red 8) RAL 5015, sky blue 9) RAL 5003, sapphire blue 10) RAL 6001, emerald green 11) HKS 54 K, signal green 12) RAL 9016, white

## Systainer<sup>3</sup> M 337 SETS



- Tool-Systainer<sup>3</sup> M 337**
- Light grey art n° 83500025
  - Anthracite art n° 83500026
  - With wooden insert for hand tools



- Cartridge-Systainer<sup>3</sup> M 337\*\*\***
- Light grey art n° 83500027
  - Anthracite art n° 83500028
  - With EPP cartridge insert



- Aerosol-Systainer<sup>3</sup> M 337\*\*\*\***
- Light grey art n° 83500031
  - Anthracite art n° 83500032
  - With EPP spray can insert



- Info-Systainer<sup>3</sup> M 337**
- Light grey art n° 83500035
  - Anthracite art n° 83500036
  - With suspension frame (suitable for DIN 821)



- Insulated Systainer<sup>3</sup> M 337 EPP**
- Light grey art n° 83500039
  - Anthracite art n° 83500040
  - With EPP insulating insert and insulating lid

## LID INSERTS



**Lid insert, EPP, 5 mm**  
• Art n° 83000044



**Lid foam, vaulted**  
• Art n° 83000035  
(Industry customers\*)  
• Art n° 83570006  
(Dealers/end users\*\*)



**Office lid**  
• Art n° 83500069

## BOTTOM INSERTS



**Base foam soft, 25 mm**  
• Art n° 83000036  
(Industry customers\*)  
• Art n° 83570007  
(Dealers/end users\*\*)



**Pick & pluck foam rigid, 25 mm**  
• Art n° 83000038  
(Industry customers\*)  
• Art n° 83570009  
(Dealers/end users\*\*)

Perforated cubes, 15 x 15 mm,  
for quarrying out



**Base foam with cross cut-out**  
• Art n° 83000037  
(Industry customers\*)  
• Art n° 83570008  
(Dealers/end users\*\*)



**Wooden insert for hand tools**  
• Art n° 83500053



**EPP cartridge insert\*\*\***  
• Art n° 83000046



**EPP spray can insert\*\*\*\***  
• Art n° 83000047



**Suspension frame  
(suitable for DIN 821)**  
• Art n° 83570003



**Divider for Insulated Systainer<sup>3</sup>**  
• Art n° 83500066  
• Set of 2



## Systainer<sup>3</sup> M 437

Tall, taller, Systainer<sup>3</sup> M 437. The tallest Systainer<sup>3</sup> offers plenty of space for large work materials and tools, and is optimally suited for insulating cartridges, spray cans and sensitive contents or packaging large objects.

### Systainer<sup>3</sup> M 437

- Light grey art n° 83000006
- Anthracite art n° 83000023

## DIMENSIONS

Outside in mm	Inside in mm	Weight	Carrying capacity	Inner volume	Pallet Pcs./H.
H* 430 x W 396 x D 296	H 394 x W 389.7 x D 275.2	2.89 kg	20 kg	43.1 l	32 / 187.7 cm

\*The outside dimensions are measured without feet: H + 7 mm

## COLORS

	Standard colors	Additional colors	
Body with lid	1)  3)	4)  5)  6)  7)  8)  9)  10)	
Lid handle	1)  3)	4)  5)  6)  7)  8)  9)  10)  11)  12)	
Catch	2)  3)	1)  4)  5)  6)  7)  8)  9)  10)  11)  12)	
1) RAL 7035, light grey	4) RAL 9004, black	7) RAL 3002, carmine red	10) RAL 6001, emerald green
2) HKS 43 K, signal blue	5) RAL 1007, daffodil yellow	8) RAL 5015, sky blue	11) HKS 54 K, signal green
3) RAL 7016, anthracite	6) RAL 2011, deep orange	9) RAL 5003, sapphire blue	12) RAL 9016, white

## Systainer<sup>3</sup> M 437 SETS



### Cartridge-Systainer<sup>3</sup> M 437\*\*\*

- Light grey art n° 83500029
- Anthracite art n° 83500030
- With EPP cartridge insert



### Aerosol-Systainer<sup>3</sup> M 437\*\*\*\*

- Light grey art n° 83500033
- Anthracite art n° 83500034
- With EPP spray can insert



### Insulated Systainer<sup>3</sup> M 437 EPP

- Light grey art n° 83500041
- Anthracite art n° 83500042
- With EPP insulating insert and insulating lid

## LID INSERTS



**Lid insert, EPP, 5 mm**  
• Art n° 83000044



**Lid foam, vaulted**  
• Art n° 83000035  
(Industry customers\*)  
• Art n° 83570006  
(Dealers/end users\*\*)



**Office lid**  
• Art n° 83500069

## BOTTOM INSERTS



**Base foam soft, 25 mm**  
• Art n° 83000036  
(Industry customers\*)  
• Art n° 83570007  
(Dealers/end users\*\*)



**Pick & pluck foam rigid, 25 mm**  
• Art n° 83000038  
(Industry customers\*)  
• Art n° 83570009  
(Dealers/end users\*\*)

Perforated cubes, 15 x 15 mm,  
for quarrying out



**Base foam with cross cut-out**  
• Art n° 83000037  
(Industry customers\*)  
• Art n° 83570008  
(Dealers/end users\*\*)



**Wooden insert for hand tools**  
• Art n° 83500053



**EPP cartridge insert\*\*\***  
• Art n° 83000046



**EPP spray can insert\*\*\*\***  
• Art n° 83000047



**Suspension frame  
(suitable for DIN 821)**  
• Art n° 83570003



**Divider for Insulated Systainer<sup>3</sup>**  
• Art n° 83500066  
• Set of 2



## Systainer<sup>3</sup> L 137

If you need a little extra storage space: Systainer<sup>3</sup> L 137. The Systainer<sup>3</sup> L 137 offers the best possible tool storage for your needs, as well as convenient carrying upright using the front handle.

### Systainer<sup>3</sup> L 137

- Light grey art n° 83000007
- Anthracite art n° 83000024

## DIMENSIONS

Outside in mm	Inside in mm	Weight	Carrying capacity	Inner volume	Pallet Pcs./H.
H* 130 x W 508 x D 296	H 94 x W 501.5 x D 275.2	1.92 kg	20 kg	13.2 l	52 / 184.7 cm

\*The outside dimensions are measured without feet: H + 7 mm

## COLORS

	Standard colors	Additional colors	
Body with lid	1)  3)	Additional colors upon request	
Lid handle		4)  5)  6)  7)  8)  9)  10)  11)  12)	
Catch	2)	1)	
1) RAL 7035, light grey	4) RAL 9004, black	7) RAL 3002, carmine red	10) RAL 6001, emerald green
2) HKS 43 K, signal blue	5) RAL 1007, daffodil yellow	8) RAL 5015, sky blue	11) HKS 54 K, signal green
3) RAL 7016, anthracite	6) RAL 2011, deep orange	9) RAL 5003, sapphire blue	12) RAL 9016, white

## Systainer<sup>3</sup> L 137 SETS



### Universal-Systainer<sup>3</sup> L 137

- Light grey art n° 83500043
- Anthracite art n° 83500044
- With lid insert, EPP, 5 mm and universal insert with 6 compartments



### Padded-Systainer<sup>3</sup> L 137

- Light grey art n° 83500045
- Anthracite art n° 83500046
- With base foam soft, 25 mm, base pick & pluck foam rigid, 25 mm, and lid foam, vaulted



## LID INSERTS



**Lid insert, EPP, 5 mm**  
• Art n° 83000045



**Lid foam, vaulted**  
• Art n° 83000040  
(Industry customers\*)  
• Art n° 83570010  
(Dealers/end users\*\*)



**Tool lid**  
• Art n° 83500070

## BOTTOM INSERTS



**Base foam soft, 25 mm**  
• Art n° 83000041  
(Industry customers\*)  
• Art n° 83570011  
(Dealers/end users\*\*)



**Pick & pluck foam rigid, 25 mm**  
• Art n° 83000043  
(Industry customers\*)  
• Art n° 83570012  
(Dealers/end users\*\*)

Perforated cubes, 15 x 15 mm,  
for quarrying out



**EPP base insert, 15 mm**  
• Art n° 83000042



**Universal insert with  
6 compartments**  
• Art n° 83000058



## Systainer<sup>3</sup> L 187

Tools, angle grinders and much more, everything has its place in the Systainer<sup>3</sup> L 187. Carry upright or easily link to a tower; transportation is easy with the Systainer<sup>3</sup> L 187.

### Systainer<sup>3</sup> L 187

- Light grey art n° 83000008
- Anthracite art n° 83000025

## DIMENSIONS

Outside in mm	Inside in mm	Weight	Carrying capacity	Inner volume	Pallet Pcs./H.
H* 180 x W 508 x D 296	H 144 x W 501.7 x D 275.2	2.14 kg	20 kg	20.2 l	36 / 177.7 cm

\*The outside dimensions are measured without feet: H + 7 mm

## COLORS

	Standard colors	Additional colors	
Body with lid	<sub>1)</sub> <sub>3)</sub>	Additional colors upon request	
Lid handle	<sub>1)</sub> <sub>3)</sub>	<sub>4)</sub> <sub>5)</sub> <sub>6)</sub> <sub>7)</sub> <sub>8)</sub> <sub>9)</sub> <sub>10)</sub> <sub>11)</sub> <sub>12)</sub>	
Catch	<sub>2)</sub> <sub>3)</sub>	<sub>1)</sub> <sub>4)</sub> <sub>5)</sub> <sub>6)</sub> <sub>7)</sub> <sub>8)</sub> <sub>9)</sub> <sub>10)</sub> <sub>11)</sub> <sub>12)</sub>	
1) RAL 7035, light grey	4) RAL 9004, black	7) RAL 3002, carmine red	10) RAL 6001, emerald green
2) HKS 43 K, signal blue	5) RAL 1007, daffodil yellow	8) RAL 5015, sky blue	11) HKS 54 K, signal green
3) RAL 7016, anthracite	6) RAL 2011, deep orange	9) RAL 5003, sapphire blue	12) RAL 9016, white

## Systainer<sup>3</sup> L 187 SETS



### Tool-Systainer<sup>3</sup> L 187

- Light grey art n° 83500047
- Anthracite art n° 83500048
- With 2 tool lids and tool insert with dividers



## LID INSERTS



**Lid insert, EPP, 5 mm**  
• Art n° 83000045



**Lid foam, vaulted**  
• Art n° 83000040  
(Industry customers\*)  
• Art n° 83570010  
(Dealers/end users\*\*)



**Tool lid**  
• Art n° 83500070

## BOTTOM INSERTS



**Base foam soft, 25 mm**  
• Art n° 83000041  
(Industry customers\*)  
• Art n° 83570011  
(Dealers/end users\*\*)



**Pick & pluck foam rigid, 25 mm**  
• Art n° 83000043  
(Industry customers\*)  
• Art n° 83570012  
(Dealers/end users\*\*)

Perforated cubes, 15 x 15 mm,  
for quarrying out



**EPP base insert, 15 mm**  
• Art n° 83000042



**Divider-set for tool insert**  
• Art n° 83500154  
• For Tool-Systainer<sup>3</sup> L 187  
• 1 x short and 1 x long divider



## Systainer<sup>3</sup> L 237

The Systainer<sup>3</sup> L 237 offers additional space. Large equipment or utensils fit into this tool case. Just like all Systainer<sup>3</sup> L sizes, it can also be linked to the Systainer<sup>3</sup> M size and systainer<sup>®</sup> T-Loc.

### Systainer<sup>3</sup> L 237

- Light grey art n° 83000009
- Anthracite art n° 83000026

## DIMENSIONS

Outside in mm	Inside in mm	Weight	Carrying capacity	Inner volume	Pallet Pcs./H.
H* 230 x W 508 x D 296	H 194 x W 501.7 x D 275.2	2.38 kg	20 kg	27.4 l	28 / 176.7 cm

\*The outside dimensions are measured without feet: H + 7 mm

## COLORS

	Standard colors	Additional colors	
Body with lid	1)  3)	Additional colors upon request	
Lid handle		4)  5)  6)  7)  8)  9)  10)  11)  12)	
Catch	2)	1)	
1) RAL 7035, light grey	4) RAL 9004, black	7) RAL 3002, carmine red	10) RAL 6001, emerald green
2) HKS 43 K, signal blue	5) RAL 1007, daffodil yellow	8) RAL 5015, sky blue	11) HKS 54 K, signal green
3) RAL 7016, anthracite	6) RAL 2011, deep orange	9) RAL 5003, sapphire blue	12) RAL 9016, white

## LID INSERTS



**Lid insert, EPP, 5 mm**  
• Art n° 83000045



**Lid foam, vaulted**  
• Art n° 83000040  
(Industry customers\*)  
• Art n° 83570010  
(Dealers/end users\*\*)



**Tool lid**  
• Art n° 83500070

## BOTTOM INSERTS



**Base foam soft, 25 mm**  
• Art n° 83000041  
(Industry customers\*)  
• Art n° 83570011  
(Dealers/end users\*\*)



**Pick & pluck foam rigid, 25 mm**  
• Art n° 83000043  
(Industry customers\*)  
• Art n° 83570012  
(Dealers/end users\*\*)

Perforated cubes, 15 x 15 mm,  
for quarrying out



**EPP base insert, 15 mm**  
• Art n° 83000042



1)

## Systainer<sup>3</sup> XXL 237 + 337

Bigger, better, stronger! The Systainer<sup>3</sup> with plenty of space and volume. The essential choice for bulky items and large materials or tools: Systainer<sup>3</sup> XXL 237 and 337.

### Systainer<sup>3</sup> XXL 237 <sup>1)</sup>

- Light grey art n° 83000016
- Anthracite art n° 83000033

### Systainer<sup>3</sup> XXL 337 <sup>2)</sup>

- Light grey art n° 83000017
- Anthracite art n° 83000034



2)

## DIMENSIONS

### Systainer<sup>3</sup> XXL 237

Outside in mm	Inside in mm	Weight	Carrying capacity	Inner volume	Pallet Pcs./H.
H* 230 x W 792 x D 296	H 188 x W 786.5 x D 279.1	3.64 kg	40 kg	42.3 l	28 / 176.7 cm

### Systainer<sup>3</sup> XXL 337

Outside in mm	Inside in mm	Weight	Carrying capacity	Inner volume	Pallet Pcs./H.
H* 330 x W 792 x D 296	H 288 x W 786.1 x D 279.1	4.33 kg	40 kg	64.2 l	20 / 180.7 cm

\*The outside dimensions are measured without feet: H + 7 mm

## COLORS

	Standard colors	Additional colors	
Body with lid		Additional colors upon request	
Lid handle			
Catch			
1) RAL 7035, light grey	4) RAL 9004, black	7) RAL 3002, carmine red	10) RAL 6001, emerald green
2) HKS 43 K, signal blue	5) RAL 1007, daffodil yellow	8) RAL 5015, sky blue	11) HKS 54 K, signal green
3) RAL 7016, anthracite	6) RAL 2011, deep orange	9) RAL 5003, sapphire blue	12) RAL 9016, white

## LID INSERTS



### Lid foam, vaulted

- Art n° 83000066 (Industry customers\*)
- Art n° 83570013 (Dealers/end users\*\*)

## BOTTOM INSERTS



### Base foam soft, 25 mm

- Art n° 83000067 (Industry customers\*)
- Art n° 83570014 (Dealers/end users\*\*)



### Pick & pluck foam rigid, 50 mm\*\*\*

- Art n° 83000068 (Industry customers\*)
- Art n° 83570015 (Dealers/end users\*\*)



### Mounting Plate

- Art n° 83500274
- incl. hook and loop fastener 3 m and fastening material



**Proven**  
T-Loc  
central controller



**Interfaces**  
to Systainer³ M + L  
and systainer® T-Loc



**Secure**  
the Systainer³  
using an integrated  
latch (Theft Tag)



**Carry**  
the Systainer³ by using the lateral integrated grip recess



**Transport**  
the case using the Systainer³  
CART "SYS-RB" roller board



**Label**  
the Systainer³ with two slots  
for custom labeling





## Systainer<sup>3</sup> ORGANIZER M 89

For fans of structure: Small parts sorting for professionals. With Systainer<sup>3</sup> Organizer M 89, every small consumable material has its place and is clearly sorted. Already fitted with insert boxes or customized, it is your choice.

### Systainer<sup>3</sup> Organizer M 89

- Light grey art n° 83000010
- Anthracite art n° 83000027

## DIMENSIONS

Outside in mm	Inside in mm	Weight	Carrying capacity	Inner volume	Pallet Pcs./H.
H* 82 x W 396 x D 296	H 60 x W 389.5 x D 246.2	1.60 kg	20 kg	7.4 l	160 / 183.7 cm

\*The outside dimensions are measured without feet: H + 7 mm

## COLORS

	Standard colors	Additional colors	
Body without lid	1)  3)	Additional colors upon request	
Catch	2)	1)  4)  5)  6)  7)  8)  9)  10)  11)  12)	
1) RAL 7035, light grey	4) RAL 9004, black	7) RAL 3002, carmine red	10) RAL 6001, emerald green
2) HKS 43 K, signal blue	5) RAL 1007, daffodil yellow	8) RAL 5015, sky blue	11) HKS 54 K, signal green
3) RAL 7016, anthracite	6) RAL 2011, deep orange	9) RAL 5003, sapphire blue	12) RAL 9016, white

## Systainer<sup>3</sup> ORGANIZER M 89 SETS



### Systainer<sup>3</sup> Organizer M 89 with 22 insert boxes

- Light grey art n° 83500001
- Anthracite art n° 83500005
- Insert boxes:
  - 13 pcs. 50 x 50,
  - 8 pcs. 50 x 100,
  - 1 pc. 100 x 150



### Systainer<sup>3</sup> Organizer M 89 with 6 insert boxes

- Light grey art n° 83500002
- Anthracite art n° 83500006
- Insert boxes:
  - 1 pc. 50 x 50,
  - 1 pc. 50 x 100,
  - 3 pcs. 100 x 150,
  - 1 pc. 100 x 350



## BOTTOM INSERTS



### Insert box set 50 x 50

- Art n° 83500055
- Set of 10
- D 50 x W 50 x H 68 mm



### Insert box set 50 x 100

- Art n° 83500056
- Set of 10
- D 50 x W 100 x H 68 mm



### Insert box set 100 x 100

- Art n° 83500057
- Set of 6
- D 100 x W 100 x H 68 mm



### Insert box set 100 x 150

- Art n° 83500058
- Set of 6
- D 100 x W 150 x H 68 mm



### Insert box set 100 x 350

- Art n° 83500059
- Set of 2
- D 100 x W 350 x H 68 mm



### Insert box set 150 x 150

- Art n° 83500060
- Set of 6
- D 150 x W 150 x H 68 mm



### Insert box set 150 x 300

- Art n° 83500061
- Set of 2
- D 150 x W 300 x H 68 mm



## Systainer<sup>3</sup> ORGANIZER L 89

The Systainer<sup>3</sup> Organizer L 89 for even better sorting. The case also organizes a broad range of consumable materials like screws and dowels. Everything is clearly sorted, and the transparent lid allows you to keep your perspective, even with the lid closed.

### Systainer<sup>3</sup> Organizer L 89

- Light grey art n° 83000011
- Anthracite art n° 83000028

## DIMENSIONS

Outside in mm	Inside in mm	Weight	Carrying capacity	Inner volume	Pallet Pcs./H.
H* 82 x W 508 x D 296	H 60 x W 501.5 x D 278.5	1.99 kg	20 kg	9.7 l	80 / 183.7 cm

\*The outside dimensions are measured without feet: H + 7 mm

## COLORS

	Standard colors	Additional colors	
Body without lid	1)  3)	Additional colors upon request	
Catch	2)	1)  4)  5)  6)  7)  8)  9)  10)  11)  12)	
1) RAL 7035, light grey	4) RAL 9004, black	7) RAL 3002, carmine red	10) RAL 6001, emerald green
2) HKS 43 K, signal blue	5) RAL 1007, daffodil yellow	8) RAL 5015, sky blue	11) HKS 54 K, signal green
3) RAL 7016, anthracite	6) RAL 2011, deep orange	9) RAL 5003, sapphire blue	12) RAL 9016, white

## Systainer<sup>3</sup> ORGANIZER L 89 SETS



### Systainer<sup>3</sup> Organizer L 89 with 20 insert boxes

- Light grey art n° 83500003
- Anthracite art n° 83500007
- Insert boxes:
  - 10 pcs. 50 x 50,
  - 6 pcs. 50 x 100,
  - 2 pcs. 100 x 100,
  - 1 pc. 100 x 150,
  - 1 pc. 150 x 150



### Systainer<sup>3</sup> Organizer L 89 with 10 insert boxes

- Light grey art n° 83500004
- Anthracite art n° 83500008
- Insert boxes:
  - 1 pc. 50 x 50,
  - 4 pcs. 50 x 100,
  - 1 pc. 100 x 100,
  - 3 pcs. 100 x 150,
  - 1 pc. 100 x 350

## BOTTOM INSERTS



### Insert box set 50 x 50

- Art n° 83500055
- Set of 10
- D 50 x W 50 x H 68 mm



### Insert box set 50 x 100

- Art n° 83500056
- Set of 10
- D 50 x W 100 x H 68 mm



### Insert box set 100 x 100

- Art n° 83500057
- Set of 6
- D 100 x W 100 x H 68 mm



### Insert box set 100 x 150

- Art n° 83500058
- Set of 6
- D 100 x W 150 x H 68 mm



### Insert box set 100 x 350

- Art n° 83500059
- Set of 2
- D 100 x W 350 x H 68 mm



### Insert box set 150 x 150

- Art n° 83500060
- Set of 6
- D 150 x W 150 x H 68 mm



### Insert box set 150 x 300

- Art n° 83500061
- Set of 2
- D 150 x W 300 x H 68 mm



1)



2)



3)

## Systainer<sup>3</sup> TOOLBOX

Everything is ready to hand in the Systainer<sup>3</sup> ToolBox! The convertible version of the Systainer<sup>3</sup> system with plenty of storage capacity for tools, working material and accessories. Thanks to the movable carrying handle and the Systainer<sup>3</sup> closing catch, Systainer<sup>3</sup> can be linked with just one flick of the wrist. It can be connected to all Systainer<sup>3</sup> and systainer<sup>®</sup> T-Loc and integrated into van racking equipment, this makes the ToolBox the perfect companion at work.

### Systainer<sup>3</sup> ToolBox M 137 <sup>1)</sup>

- Light grey art n° 83000012
- Anthracite art n° 83000029

### Systainer<sup>3</sup> ToolBox M 237 <sup>2)</sup>

- Light grey art n° 83000013
- Anthracite art n° 83000030

### Systainer<sup>3</sup> ToolBox L 137 <sup>3)</sup>

- Light grey art n° 83000014
- Anthracite art n° 83000031

### Systainer<sup>3</sup> ToolBox L 237 <sup>4)</sup>

- Light grey art n° 83000015
- Anthracite art n° 83000032



4)

## DIMENSIONS

### Systainer<sup>3</sup> ToolBox M 137

Outside in mm	Inside in mm	Weight	Carrying capacity	Inner volume	Pallet Pcs./H.
H* 130 x W 396 x D 296	H 122 x W 357.8 x D 221	1.30 kg	20 kg	10.4 l	104 / 184.7 cm

### Systainer<sup>3</sup> ToolBox M 237

Outside in mm	Inside in mm	Weight	Carrying capacity	Inner volume	Pallet Pcs./H.
H* 230 x W 396 x D 296	H 222 x W 357.8 x D 221	1.70 kg	20 kg	21.4 l	56 / 176.7 cm

### Systainer<sup>3</sup> ToolBox L 137

Outside in mm	Inside in mm	Weight	Carrying capacity	Inner volume	Pallet Pcs./H.
H* 130 x W 508 x D 296	H 120 x W 461.1 x D 221	1.90 kg	20 kg	13.2 l	52 / 184.7 cm

### Systainer<sup>3</sup> ToolBox L 237

Outside in mm	Inside in mm	Weight	Carrying capacity	Inner volume	Pallet Pcs./H.
H* 230 x W 508 x D 296	H 220 x W 461.1 x D 221	2.40 kg	20 kg	27.4 l	28 / 176.7 cm

\*The outside dimensions are measured without feet: H + 7 mm

## COLORS

	Standard colors	Additional colors
Body with carrying handle	1)  3)	Additional colors upon request
Catch	2)	1)  4)  5)  6)  7)  8)  9)  10)  11)  12)
	1) RAL 7035, light grey 2) HKS 43 K, signal blue 3) RAL 7016, anthracite	4) RAL 9004, black 5) RAL 1007, daffodil yellow 6) RAL 2011, deep orange 7) RAL 3002, carmine red 8) RAL 5015, sky blue 9) RAL 5003, sapphire blue 10) RAL 6001, emerald green 11) HKS 54 K, signal green 12) RAL 9016, white

## BOTTOM INSERTS Systainer<sup>3</sup> M



### Base foam soft, 25 mm

- Art n° 83000036 (Industry customers\*)
- Art n° 83570007 (Dealers/end users\*\*)



### Pick & pluck foam rigid, 25 mm\*\*\*

- Art n° 83000038 (Industry customers\*)
- Art n° 83570009 (Dealers/end users\*\*)



### Base foam with cross cut-out

- Art n° 83000037 (Industry customers\*)
- Art n° 83570008 (Dealers/end users\*\*)

## BOTTOM INSERTS Systainer<sup>3</sup> L



### Base foam soft, 25 mm

- Art n° 83000041 (Industry customers\*)
- Art n° 83570011 (Dealers/end users\*\*)



### Pick & pluck foam rigid, 25 mm\*\*\*

- Art n° 83000043 (Industry customers\*)
- Art n° 83570012 (Dealers/end users\*\*)

## GOOD TO KNOW

- Open Systainer<sup>3</sup> design provides optimal overview of the contents
- Hand tools and consumables easily at hand
- Can be carried comfortably thanks to the wide and moveable carrying handle
- Systainer<sup>3</sup> ToolBox comes in 4 different dimensions





## Systainer<sup>3</sup> LID COMPARTMENT M

Keep everything sorted, easy to find, and right at hand! The Systainer<sup>3</sup> lid compartment M is ideal for power tools with accessories. See immediately what parts, drill bits, or jigsaw blades you have thanks to the transparent lid. Separators allow for flexible division and custom organization of the lid compartment. The Systainer<sup>3</sup> is a great way to store hand-held tools, power tools, accessories, small components or other work equipment.



1)



2)



3)

### Systainer<sup>3</sup> lid compartment M 137 <sup>1)</sup>

- Light grey art n° 83000563
- Anthracite art n° 83000564

### Systainer<sup>3</sup> lid compartment M 187 <sup>2)</sup>

- Light grey art n° 83000561
- Anthracite art n° 83000562

### Systainer<sup>3</sup> lid compartment M 237 <sup>3)</sup>

- Light grey art n° 83000559
- Anthracite art n° 83000560

Incl. separators for variable division of the sections in the lid compartment:  
4 x long separators,  
10 x short separators,  
8 x connectors



## DIMENSIONS

### Systainer<sup>3</sup> lid compartment M 137

Outside in mm	Inside in mm	Weight	Carrying capacity	Inner volume	Pallet Pcs./H.
H* 130 x W 396 x D 296	H 96 x W 389.5 x D 275	1.70 kg	20 kg	10.4 l	104 / 184.7 cm

### Systainer<sup>3</sup> lid compartment M 187

Outside in mm	Inside in mm	Weight	Carrying capacity	Inner volume	Pallet Pcs./H.
H* 180 x W 396 x D 296	H 146 x W 389.7 x D 275.2	1.90 kg	20 kg	15.9 l	72 / 177.7 cm

### Systainer<sup>3</sup> lid compartment M 237

Outside in mm	Inside in mm	Weight	Carrying capacity	Inner volume	Pallet Pcs./H.
H* 230 x W 396 x D 296	H 196 x W 389.7 x D 275.2	2.10 kg	20 kg	21.4 l	56 / 176.7 cm

\*The outside dimensions are measured without feet: H + 7 mm

## COLORS

	Standard colors	Additional colors	
Body with lid		Additional colors upon request	
Lid handle			
Catch			
1) RAL 7035, light grey	4) RAL 9004, black	7) RAL 3002, carmine red	10) RAL 6001, emerald green
2) HKS 43 K, signal blue	5) RAL 1007, daffodil yellow	8) RAL 5015, sky blue	11) HKS 54 K, signal green
3) RAL 7016, anthracite	6) RAL 2011, deep orange	9) RAL 5003, sapphire blue	12) RAL 9016, white

## LID INSERTS



### Bit cassette

- Art n° 83000566
- for Systainer<sup>3</sup> lid compartment M, consisting of 4 removable bit mounts with magnetic holder of 6 bits each



### SDS cassette

- Art n° 83000565
- for Systainer<sup>3</sup> lid compartment M, for 7 SDS drill bits diameter: 1 x 12, 1 x 10, 1 x 8, 3 x 6, 1 x 5



### Lid foam, vaulted

- Art n° 83000035 (Industry customers\*)
- Art n° 83570006 (Dealers/end users\*\*)

## BOTTOM INSERTS



### Base foam soft, 25 mm

- Art n° 83000036 (Industry customers\*)
- Art n° 83570007 (Dealers/end users\*\*)



### Pick & pluck foam rigid, 25 mm\*\*\*

- Art n° 83000038 (Industry customers\*)
- Art n° 83570009 (Dealers/end users\*\*)



### Base foam with cross cut-out

- Art n° 83000037 (Industry customers\*)
- Art n° 83570008 (Dealers/end users\*\*)

## BOTTOM INSERTS Systainer<sup>3</sup> LID COMPARTMENT M 137



### Insert for cordless drill

- Art n° 83000053

## BOTTOM INSERTS Systainer<sup>3</sup> LID COMPARTMENT M 187



### Insert for angle grinder

Ø 125 mm

- Art n° 83000054



### Insert for oscillator

- Art n° 83000055



### Foam for fixation for insert for oscillator

- Art n° 83500077

## BOTTOM INSERTS Systainer<sup>3</sup> LID COMPARTMENT M 237



### Set of 3 dividers

- Art n° 83500054



1)



2)

## systainer® T-LOC SYS-COMBI II + III

The perfect combination of systainer® and integrated drawer. Everything that belongs together stays together, for more tidiness in your daily routine. Available in two sizes.

### systainer® T-Loc “SYS-Combi II” with drawer incl. 2 separating webs 1)

- Light grey art n° 80101816
- Anthracite art n° 80101817

### systainer® T-Loc “SYS-Combi III” with drawer incl. 2 separating webs 2)

- Light grey art n° 80101818
- Anthracite art n° 80101819



systainer® at the top – drawer  
at the bottom

## DIMENSIONS

### systainer® T-Loc “SYS-Combi II”

Outside in mm	Inside in mm	Weight	Pallet Pcs. / H.
H* 263 x W 396 x D 296	H 127.5 x W 383 x D 267	3.20 kg	48 / 173 cm
Drawer	H 69 x W 350 x D 255	–	–

### systainer® T-Loc “SYS-Combi III”

Outside in mm	Inside in mm	Weight	Pallet Pcs. / H.
H* 315 x W 396 x D 296	H 180 x W 383 x D 266	3.50 kg	40 / 173 cm
Drawer	H 69 x W 350 x D 255	–	–

\*The outside dimensions are measured without feet: H + 7 mm

## COLORS

	Standard colors	Additional colors	
Body with lid	1)  3)		
Handle		4)  5)  6)  7)  8)  9)  10)  11)  12)	
T-Loc catch	2)	1)	
1) RAL 7035, light grey	4) RAL 9004, black	7) RAL 3002, carmine red	10) RAL 6001, emerald green
2) HKS 43 K, signal blue	5) RAL 1007, daffodil yellow	8) RAL 5015, sky blue	11) HKS 54 K, signal green
3) RAL 7016, anthracite	6) RAL 2011, deep orange	9) RAL 5003, sapphire blue	12) RAL 9016, white



## LID INSERTS



### Lid foam, vaulted

- Art n° 83000035  
(Industry customers\*)
- Art n° 83570006  
(Dealers/end users\*\*)



### Office lid

- Art n° 83500069



### Tool lid set

- Art n° 80500034
- Tool lid with loop and tool lid insert double-sided equipable
- Incl. fixing rod

## BOTTOM INSERTS



### Base foam soft, 25 mm

- Art n° 83000036  
(Industry customers\*)
- Art n° 83570007  
(Dealers/end users\*\*)



### Pick & pluck foam rigid, 25 mm\*\*\*

- Art n° 83000038  
(Industry customers\*)
- Art n° 83570009  
(Dealers/end users\*\*)



### Base foam with cross cutting

- Art n° 80101004  
(Industry customers\*)
- Art n° 83570075  
(Dealers/end users\*\*)



### Base foam for drawers, 5 mm, rigid

- Art n° 80102318  
(Industry customers\*)
  - Art n° 83570145  
(Dealers/end users\*\*)
- Perforated parting line



### Pick & pluck foam for drawers, 30 mm, rigid\*\*\*

- Art n° 80102319  
(Industry customers\*)
  - Art n° 83570146  
(Dealers/end users\*\*)
- Perforated parting line



### Insert for angle grinder Ø 125 mm, for systainer® T-Loc „SYS-Combi II“

- Art n° 83000054



### Insert for oscillator, for systainer® T-Loc „SYS-Combi II“

- Art n° 83000055



### Tool tray

- Art n° 80101018
- With compartments for hammer, folding rule, angle bracket and 2 pockets for accessories

### Foam for fixation for insert for oscillator

- Art n° 83500077 (image see page 63)

### Accessories set for drawers\*\*\*\*

- Art n° 80590683 (image see page 67)

### Divider, set of 3 for drawers

- Art n° 80590736 (image see page 67)



### Insert for cordless drill, for systainer® T-Loc „SYS-Combi II“

- Art n° 83000053



### Insert for abrasives Ø 150 mm, for systainer® T-Loc „SYS-Combi III“

- Art n° 83000057



1)

## SORTAINER T-LOC “SYS-SORT IV / 3” AND RACK-systemer<sup>®</sup> IV

The name says it all! Sorting is fun with the Sortainer T-Loc and the Rack-systemer<sup>®</sup> and ensures practical orderliness of all small parts.

### Sortainer T-Loc “SYS-Sort IV / 3”<sup>1)</sup>

- Light grey art n° 80101820
- Anthracite art n° 80101821
- With 3 drawers, each drawer with 2 dividers

### Rack-systemer<sup>®</sup> IV<sup>2)</sup>

- Light grey art n° 80590041
- Anthracite art n° 80590042
- With 4 Rack-boxes (2 x 15 and 2 x 17 interchangeable boxes)



2)

The perfect complement:  
3 drawers enable maximum flexibility due to variable and individual division.



## DIMENSIONS

### Sortainer T-Loc “SYS-Sort IV / 3”

Outside in mm	Inside in mm	Weight	Pallet Pcs. / H.
H* 315 x W 396 x D 296	–	5.94 kg	40 / 173 cm
Drawer	H 69 x W 350 x D 255	–	–

### Rack-systemer<sup>®</sup> IV

Outside in mm	Inside in mm	Weight	Pallet Pcs. / H.
H* 315 x W 400 x D 300	–	6.80 kg	40 / 173 cm

\*The outside dimensions are measured without feet: H + 7 mm

## COLORS

### Sortainer T-Loc "SYS-Sort IV / 3"

	Standard colors	Additional colors
Body with lid	1)  3)	
Handle	1)  3)	4)  5)  6)  7)  8)  9)  10)  11)  12)
SYS-Sort catch	2)  3)	1)  4)  5)  6)  7)  8)  9)  10)  11)  12)

### Rack-systainer® IV

	Standard colors	Additional colors
Body and handle	1)  3)	
Front catches	2)  3)	5)  7)  8)  10)  11)
Back catches	2)  3)	1)  4)  5)  7)  8)  9)  10)  11)  12)

- 1) RAL 7035, light grey  
2) HKS 43 K, signal blue  
3) RAL 7016, anthracite

- 4) RAL 9004, black  
5) RAL 1007, daffodil yellow  
6) RAL 2011, deep orange

- 7) RAL 3002, carmine red  
8) RAL 5015, sky blue  
9) RAL 5003, sapphire blue

- 10) RAL 6001, emerald green  
11) HKS 54 K, signal green  
12) RAL 9016, white

## BOTTOM INSERTS SORTAINER T-LOC „SYS-SORT IV / 3“



#### Base foam for drawers, 5 mm, rigid

- Art n° 80102318 (Industry customers\*)
- Art n° 83570145 (Dealers/end users\*\*)

Perforated parting line



#### Pick & pluck foam for drawers, 30 mm, rigid

- Art n° 80102319 (Industry customers\*)
- Art n° 83570146 (Dealers/end users\*\*)

Perforated cubes, 15 x 15 mm, for quarrying out, perforated parting line



#### Accessories set for drawers

- Art n° 80590683
- Consisting of 2 x foam, 4 x insert box medium (H 71 x W 120 x D 60 mm), 8 x insert box small (H 71 x W 60 x D 60 mm) and 3 x dividers



#### Divider, set of 3 for drawers

- Art n° 80590736

## BOTTOM INSERTS RACK-systainer® IV



#### Rack-Box 1 (15 indiv. boxes)

- Light grey art n° 80000058
- Anthracite art n° 80000060



#### Rack-Box 2 (17 indiv. boxes)

- Light grey art n° 80000059
- Anthracite art n° 80000061



1)

## DRAWER-systainer<sup>®</sup> III

The agony of choice. Our Drawer-systainer<sup>®</sup> from the Classic-Line series have been proven for many years and a systainer<sup>®</sup> tower without them is hard to imagine.

### Drawer-systainer<sup>®</sup> III – variant 1 <sup>1)</sup>

- Light grey art n° 80000017
- Anthracite art n° 80000023
- 1 x drawer big, 1 x drawer medium, 2 x drawer small
- Incl. labelling set and 2 dividers per drawer



2)

### Drawer-systainer<sup>®</sup> III – variant 3 <sup>2)</sup>

- Light grey art n° 80000019
- 12 x drawer small
- Incl. labelling set and 2 dividers per drawer



3)

### Drawer-systainer<sup>®</sup> III – variant 4 <sup>3)</sup>

- Light grey art n° 80000020
- 6 x drawer medium
- Incl. labelling set and 2 dividers per drawer

## DIMENSIONS

Outside in mm	Inside in mm	Weight	Pallet Pcs. / H.
H* 210 x W 400 x D 300	–	4.00 kg	64 / 183 cm

\*The outside dimensions are measured without feet: H + 5 mm

## COLORS

	Standard colors	Additional colors
Body and handle	1)  3)	
Front catches	2)  3)	1)  5)  7)  8)  10)  11)
Back catches	2)  3)	1)  4)  5)  7)  8)  9)  10)  11)  12)
	1) RAL 7035, light grey 2) HKS 43 K, signal blue 3) RAL 7016, anthracite	4) RAL 9004, black 5) RAL 1007, daffodil yellow 6) RAL 2011, deep orange 7) RAL 3002, carmine red 8) RAL 5015, sky blue 9) RAL 5003, sapphire blue 10) RAL 6001, emerald green 11) HKS 54 K, signal green 12) RAL 9016, white

## BOTTOM INSERTS



### Drawer small, indiv.

- Light grey art n° 80000086
- Anthracite art n° 80000089
- H 34 x W 78 x D 255 mm

### Divider for drawer small, set of 10

- Light grey art n° 80000092
- Anthracite art n° 80000095



### Drawer medium, indiv.

- Light grey art n° 80000087
- Anthracite art n° 80000090
- H 34 x W 167 x D 255 mm

### Divider for drawer medium, set of 5

- Light grey art n° 80000093
- Anthracite art n° 80000096



### Drawer big, indiv.

- Light grey art n° 80000088
- Anthracite art n° 80000091
- H 85 x W 350 x D 255 mm

### Divider for drawer big, set of 2

- Light grey art n° 80000094
- Anthracite art n° 80000097



1)



2)

## MINI-systainer® T-LOC I

Our MINI-systainer® T-Loc I are true space magicians despite their slim dimensions! They are very easy to integrate in the systemer® and the MIDI-systainer® and are ideal for stowing small parts.

### MINI-systainer® T-Loc I 1)

- Light grey art n° 80101365
- Anthracite art n° 80101366

### MINI-systainer® T-Loc I with transparent lid 2)

- Light grey art n° 80102100

## DIMENSIONS

### MINI-systainer® T-Loc I + transparent lid

Outside in mm	Inside in mm	Weight	Pallet Pcs. / H.
H* 71 x W 265 x D 171	H 53 x W 254.5 x D 154.5	0.43 kg	400 / 192 cm

\*The outside dimensions are measured without feet: H + 7 mm

## COLORS

	Standard colors	Additional colors	
Body with lid	1)  3)		
Handle			
T-Loc catch	2)	1)  4)  5)  6)  7)  8)  9)  10)  11)  12)	
1) RAL 7035, light grey	4) RAL 9004, black	7) RAL 3002, carmine red	10) RAL 6001, emerald green
2) HKS 43 K, signal blue	5) RAL 1007, daffodil yellow	8) RAL 5015, sky blue	11) HKS 54 K, signal green
3) RAL 7016, anthracite	6) RAL 2011, deep orange	9) RAL 5003, sapphire blue	12) RAL 9016, white

## MINI-systainer® T-LOC I SETS



**Universal-MINI-systainer® T-Loc I**

- Light grey art n° 80590510
- Anthracite art n° 80590511
- With lid insert, EPP and universal insert with 8 compartments



**MINI-systainer® T-Loc I for small parts with 3 compartments**

- Light grey art n° 80590504
- Anthracite art n° 80590505
- With lid insert, EPP and insert with 3 compartments



**MINI-systainer® T-Loc I for small bits with 5 compartments**

- Light grey art n° 80590506
- Anthracite art n° 80590507
- With lid insert, EPP and insert with 5 compartments



**MINI-systainer® T-Loc I for small bits with 6 compartments**

- Light grey art n° 80590508
- Anthracite art n° 80590509
- With lid insert, EPP and insert with 6 compartments



#### Universal-MINI-systainer® T-Loc I

- Light grey art n° 80590803
- With transparent lid, transparent cover and universal insert with 8 compartments



#### MINI-systainer® T-Loc I for small parts, 3 compartments

- Light grey art n° 80590804
- With transparent lid, transparent cover and insert with 3 compartments



#### MINI-systainer® T-Loc I for small bits, 5 compartments

- Light grey art n° 80590805
- With transparent lid, transparent cover and insert with 5 compartments



#### MINI-systainer® T-Loc I for small bits, 6 compartments

- Light grey art n° 80590806
- With transparent lid, transparent cover and insert with 6 compartments

## LID INSERTS



#### Lid insert, EPP

- Art n° 80101910



#### Lid foam, vaulted

- Art n° 80101373 (Industry customers\*)
- Art n° 83570104 (Dealers/end users\*\*)



#### Transparent cover

- Art n° 80590802
- For MINI-systainer® T-Loc I with transparent lid
- Incl. fastening materials

## BOTTOM INSERTS



#### Base foam, vaulted

- Art n° 80101375 (Industry customers\*)
- Art n° 83570105 (Dealers/end users\*\*)



#### Pick & pluck foam, 40 mm, soft\*\*\*

- Art n° 80101376 (Industry customers\*)
- Art n° 83570106 (Dealers/end users\*\*)



#### Pick & pluck foam, 40 mm, rigid\*\*\*

- Art n° 80101377 (Industry customers\*)
- Art n° 83570107 (Dealers/end users\*\*)



#### Universal insert with 8 compartments

- Art n° 80101381



#### Insert with 3 compartments

- Art n° 80101378



#### Insert with 5 compartments

- Art n° 80101379



#### Insert with 6 compartments

- Art n° 80101380



## MINI-systainer® T-LOC III

Our MINI-systainer® T-Loc III with its greater height offers even more volume for optimum utilisation of the interior space! Of course, this model is also very easy to integrate into the systainer® and the MIDI-systainer®.

### MINI-systainer® T-Loc III

- Light grey art n° 80102122
- Anthracite art n° 80102123

## DIMENSIONS

Outside in mm	Inside in mm	Weight	Pallet Pcs. / H.
H* 142 x W 265 x D 171	H 124 x W 254.5 x D 154.5	0.60 kg	192 / 198 cm

\*The outside dimensions are measured without feet: H + 7 mm

## COLORS

	Standard colors	Additional colors	
Body with lid	1)  3)		
Handle			
T-Loc catch	2)	1)  4)  5)  6)  7)  8)  9)  10)  11)  12)	
1) RAL 7035, light grey	4) RAL 9004, black	7) RAL 3002, carmine red	10) RAL 6001, emerald green
2) HKS 43 K, signal blue	5) RAL 1007, daffodil yellow	8) RAL 5015, sky blue	11) HKS 54 K, signal green
3) RAL 7016, anthracite	6) RAL 2011, deep orange	9) RAL 5003, sapphire blue	12) RAL 9016, white



## LID INSERTS



**Lid insert, EPP**  
• Art n° 80101910



**Lid foam, vaulted**  
• Art n° 80101373  
(Industry customers\*)  
• Art n° 83570104  
(Dealers/end users\*\*)

## BOTTOM INSERTS



**Base foam, vaulted**  
• Art n° 80101375  
(Industry customers\*)  
• Art n° 83570105  
(Dealers/end users\*\*)



**Pick & pluck foam, 40 mm, soft\*\*\***  
• Art n° 80101376  
(Industry customers\*)  
• Art n° 83570106  
(Dealers/end users\*\*)



**Pick & pluck foam, 40 mm, rigid\*\*\***  
• Art n° 80101377  
(Industry customers\*)  
• Art n° 83570107  
(Dealers/end users\*\*)



## systainer<sup>®</sup> STORAGE-BOX

The easily removable systainer<sup>®</sup> Tool- and Storage-Boxes are the ideal companions for flexibility and mobility everywhere.



### systainer<sup>®</sup> Storage-Box

- Light grey art n° 80101490
- Anthracite art n° 80101491
- With removable insert-boxes  
(2 x small, 2 x medium, 1 x big)



## DIMENSIONS

Outside in mm	Inside in mm	Weight	Pallet Pcs. / H.
H* 160 x W 396 x D 296 Height with handle*: 233 mm	–	2.50 kg	88 / 196 cm

\*The outside dimensions are measured without feet: H + 7 mm

## COLORS

	Standard colors	Additional colors	
Body and handle	1)  3)		
Catches	2)  3)	1)  4)  5)  7)  8)  9)  10)  11)  12)	
1) RAL 7035, light grey	4) RAL 9004, black	7) RAL 3002, carmine red	10) RAL 6001, emerald green
2) HKS 43 K, signal blue	5) RAL 1007, daffodil yellow	8) RAL 5015, sky blue	11) HKS 54 K, signal green
3) RAL 7016, anthracite	6) RAL 2011, deep orange	9) RAL 5003, sapphire blue	12) RAL 9016, white

## BOTTOM INSERTS



### Insert-box small

for systainer® Storage-Box

- Light grey art n° 80101555
- Outside dimensions:  
D 60 x W 60 x H 71 mm



### Insert-box medium

for systainer® Storage-Box

- Light grey art n° 80101556
- Outside dimensions:  
D 60 x W 120 x H 71 mm

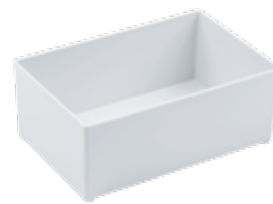

### Insert-box big

for systainer® Storage-Box

- Light grey art n° 80101557
- Outside dimensions:  
D 120 x W 180 x H 71 mm

## GOOD TO KNOW

- Excellent organisation of small parts with removable insert boxes
- Individual and flexible equipment
- Clear order of small parts
- Everything, from small parts to hand tools, always ready at hand





## INDIVIDUALISATION

Whether you choose outside labelling for quick recognition of the contents, or our labelling system for the inside of the systemer® – there are various easy and uncomplicated ways to individualise your systemer®.

## LABELING



### Label set for Systainer<sup>3</sup> Organizer insert boxes

- Small Set art n° 83500051
- Consisting of 30 paper labels and 12 transparent plug-in labels
- Large Set art n° 83500052
- Consisting of 60 paper labels and 25 transparent plug-in labels



### Label set for Systainer<sup>3</sup>, systemer® T-Loc „SYS-Combi II + III“, Sortainer T-Loc „SYS-Sort IV / 3“ and Drawer „SYS-AZ“

- Art n° 80500043
- Consisting of 20 transparent plug-in cards and 2 label sheets of 10 paper cards each



### Label set for MINI-systemer® T-Loc III

- Art n° 80590810
- Consisting of 20 transparent plug-in cards and 1 label sheet with 18 paper cards each

Printing, adhesive labels, or plug-in card printing on requests – we will be glad to advise you about the countless possibilities.



## SAFETY



### systainer® T-Loc safety set

for systainer® T-Loc „SYS-Combi II + III“

- Light grey art n° 80101201
- Consisting of lockable T-Loc catch, metal barrier, protective washer, clip and 2 keys



### TSA-lock for Systainer³

- Art n° 83570153
- TSA combination lock, which is perfectly suitable to lock Systainer³.



### Pull-tight seal

- Art n° 83500325
- 50 pieces
- For Systainer³ M, L, XXL, Organizer, Systainer³ lid compartment M

## ANTI-SLIP MATS

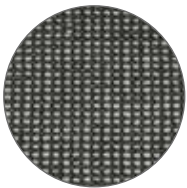

T-Exact

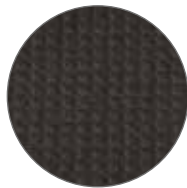

T-Tec

### Anti-slip mats

- Material thickness: 2.5 mm
- Anti-slip mats T-Exact or T-Tec
- The Anti-slip mats offer fast and secure hold for objects. They provide an extremely good non-slip function using only thin materials. This allows them to adapt optimally to the substrate and stick to the surface on both sides without adhesive.
- Different standard sizes available, just ask us.

## SYSTAINER³ XXS



### Systainer³ XXS 33

- Light grey art n° 83000089
- Outside dimensions: H 31.3 x W 105 x D 66 mm
- Inside dimensions: H 23 x W 102 x D 59 mm
- Weight: 0.04 kg



### Insert for bits

- Art n° 83000279
- Insert for up to 18 bits and one bit holder

## FLEXIBLE AT ALL TIMES

The working environment is changing and flexible work times are today as much a part of the daily routine as flexible application sites. In our "Mobile Work" section you will find innovative systemer<sup>®</sup> solutions with which you can work any time, anywhere. Freedom all around!

### MOBILE WORK



#### Mobile Workshop MW 1000 Basic

- Black/light grey/aluminium art n° 80102241
- Incl. 1 x drawer SYS-AZ-MW 1000
- Dimensions: L 641 x W 600 x H 1076 mm
- Work surface: 445 x 363 mm
- Working height: 900 mm
- Total load: 100 kg
- Weight: 19 kg



#### Mobile Workshop MW 1000

- Black/light grey/aluminium art n° 80591031
- Incl. 1 x drawer SYS-AZ-MW 1000 and table TSB/1-MW 1000
- Dimensions: L 641 x W 600 x H 1076 mm
- Work surface: 445 x 363 mm plus table TSB/1-MW 1000: 970 x 445 mm
- Working height: 900 mm
- Total load: 100 kg
- Weight: 31.2 kg



#### Drawer SYS-AZ-MW 1000

- Black/light grey art n° 80102243
- Dimensions: L 493 x W 373 x H 118 mm
- Total Load: 20 kg (assembled)
- Weight: 3.2 kg



#### Table TSB/1-MW 1000

- Aluminium/MDF art n° 80102244
- Dimensions: L 1045 x W 500 x H 74 mm
- Work surface: 970 x 445 mm
- Working height: 900 mm
- Total load: 100 kg
- Weight: 12.2 kg

## MOBILE WORK

---



### Multifunctional table "SYS-MFT"

- Light grey art n° 80600244
  - Anthracite art n° 80600245
  - systemer<sup>®</sup> T-Loc with special lid and work surface made of MDF
  - Flexible workbench for the fixation of working material
  - Integrated adhesive strip for a slip-proof surface
  - Cut-outs for lever and screw clamps
  - Outside dimensions: H\* 105 x W 396 x D 296 mm
  - Inside dimensions: H 75 x W 383 x D 273 mm
  - Weight: 2 kg
-

### MOBILE WORK



#### Systainer³ CART "SYS-RB"

- Light grey/blue art n° 83500064
- Anthracite art n° 83500065
- For Systainer³ M, L, XXL, Systainer³ Organizer M + L, Systainer³ lid compartment M, Systainer³ ToolBox M + L, MIDI-systainer® T-Loc II + III, systainer® T-Loc I - V, „SYS-Combi II + III“, Sortainer T-Loc „SYS-Sort IV / 3“, systainer® Tool-Box 1 + 2, and systainer® Storage-Box
- Even surface for the transport of various objects, integrated vehicle mount for both vario3 vehicle equipment, four recessed grips on the sides for simple carrying, four swivel castors, two of them with brake function, big wheels (diameter: 100 mm) and wheel bases for optimal running
- Mount for tie-down straps
- Dimensions: H 159 x W 508 x D 396 mm
- Carrying capacity: 100 kg
- Net weight: 2.94 kg



#### Caster "SYS-CART"

- Anthracite art n° 80600421
- For Systainer³ M, Systainer³ Organizer M, Systainer³ lid compartment M, Systainer³ ToolBox M, systainer® T-Loc, Classic-Line I-V, systainer® T-Loc „SYS-Combi II + III“, Sortainer T-Loc „SYS-Sort IV / 3“, Drawer-systainer®, Rack-systainer® IV, systainer® Tool-Box 1 + 2 and systainer® Storage-Box
- Four swivel castors, two of them with brake function
- Big wheels (diameter: 100 mm) and wheel bases for optimal running, recessed grips on the sides and through holes for U-lock
- Dimensions: H 157 x W 519 x D 365 mm
- Carrying capacity: 100 kg
- Net weight: 3.1 kg



#### Transport trolley "SYS-Roll"

- Black/light grey art n° 80101699
- Comfortable transport of Systainer³ M, Systainer³ Organizer M, Systainer³ lid compartment M, Systainer³ ToolBox M, systainer® T-Loc and Classic Line I - V, systainer® T-Loc „SYS-Combi II + III“, Sortainer T-Loc „SYS-Sort IV / 3“, Drawer-systainer®, Rack-systainer® IV, systainer® Tool-Box 1 + 2 and systainer® Storage-Box
- Roll board and sack barrow function
- Easy transportation up and down steps due to extra large wheels
- Rotating and lockable front wheels
- Integrated drawer for storing small parts
- Variably adjustable safety belt included
- Wheels-Ø front: 75 mm
- Wheels-Ø back: 200 mm
- Dimensions: H 1,100 x W 600 x D 440 mm
- Weight: 9.4 kg
- Carrying capacity: 100 kg
- Carrying capacity drawer: 5 kg



## MOBILE WORK



### Transport trolley "MAXI-TRAPO"

- Light grey/blue art n° 83570001
- For Systainer<sup>3</sup> M, L, XXL, Systainer<sup>3</sup> ToolBox M + L, Systainer<sup>3</sup> lid compartment M, Systainer<sup>3</sup> Organizer M + L, systainer<sup>®</sup> I - V, MIDI-systainer<sup>®</sup> T-Loc II + III, systainer<sup>®</sup> T-Loc „SYS-Combi II + III“, Sortainer T-Loc „SYS-Sort IV / 3“, Drawer-systainer<sup>®</sup>, Rack-systainer<sup>®</sup> IV, MAXI-systainer<sup>®</sup> II + III, systainer<sup>®</sup> Tool-Box 1 + 2 and systainer<sup>®</sup> Storage-Box
- With foldable carrier frame (L 425 x W 280 mm)
- Light running wheels with wheel covers and curved handle for a comfortable use even when it is heavily loaded
- Carrying capacity: 150 kg
- Net weight: 12 kg
- Height: 1,100 mm



### Safety strap for "MAXI-TRAPO"

- Blue/black, length: 1500 mm art n° 83570000
- Blue/black, length: 2500 mm art n° 83570154
- To be clipped on the frame work

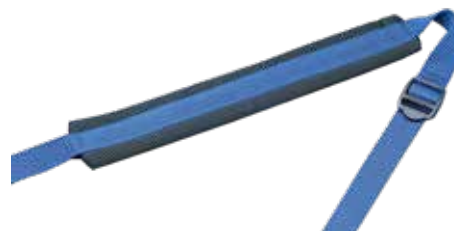

### Carrying strap

- Blue/black art n° 83570002
- For the fixation on the handle
- For Systainer<sup>3</sup> M, L, XXL, Systainer<sup>3</sup> lid compartment M, Systainer<sup>3</sup> ToolBox M + L, systainer<sup>®</sup> T-Loc „SYS-Combi II + III“, Sortainer T-Loc „SYS-Sort IV / 3“, Drawer-systainer<sup>®</sup>, Rack-systainer<sup>®</sup> IV, MAXI-systainer<sup>®</sup> II + III, systainer<sup>®</sup> Tool-Box 1 + 2 and systainer<sup>®</sup> Storage-Box
- With shoulder pad and adjustable strap

## LITTLE HELPERS – BIG RESULTS

Our developers and product managers are working day in day out on new ideas and innovations for every greater user friendliness. It is often the little useful accessories which provide the greatest services.

### STATIONARY WORK



#### Systainer<sup>3</sup> BASE – wall/base support

- Light grey/blue art n° 83500067
- Anthracite art n° 83500068
- For Systainer<sup>3</sup> M, L, XXL, Systainer<sup>3</sup> Organizer M + L, Systainer<sup>3</sup> lid compartment M, Systainer<sup>3</sup> ToolBox M + L, systainer® T-Loc „SYS-Combi II + III“, Sortainer T-Loc „SYS-Sort IV / 3“, systainer® Tool-Box 1 + 2 and systainer® Storage-Box
- Delivery without fastening materials!
- Dimensions: H 48 x W 508 x D 396 mm
- Net weight: 1.59 kg



#### Wall/base support “SYS-CART Base”

- Light grey/blue art n° 80590551
- For Systainer<sup>3</sup> M, Systainer<sup>3</sup> lid compartment M, Systainer<sup>3</sup> ToolBox M, systainer® T-Loc “SYS-Combi II + III“, Sortainer T-Loc “SYS-Sort IV / 3“, Schubladen-systainer®, Rack-systainer® IV, systainer® Tool-Box 1 + 2 and systainer® Storage-Box
- 4 recesses for the fixation with fastening (Delivery without fastening!)
- Dimensions: H 46 x W 519 x D 365 mm
- Net weight: 1.55 kg



#### Drawer “SYS-AZ”

- Individual light grey art n° 80101664
- Set of 5 light grey art n° 80590641
- Pull-out shelf, suitable for all systainer®-generations except Systainer<sup>3</sup> L, XXL, Systainer<sup>3</sup> Organizer L, Systainer<sup>3</sup> ToolBox L, MINI-, MIDI-, MAXI-systainer®
- Telescopic rails are suitable for 32 mm hole line for a variable positioning of the systainer® in your individual furnishing system
- High quality full extension slide allows to open the lid of the systainer® completely
- Centred operating element in anthracite for locking / unlocking. Simple and fast self-assembly
- Individual labelling possible thanks to integrated field for plug-in cards. Barrel lock can be added
- Outside dimensions: H 57 x W 425 x D 376 mm
- Inside dimensions: H 50 x W 395 x D 300 mm
- Weight: 2.23 kg / pc.
- Carrying capacity: 20 kg

## STATIONARY WORK

---



### Barrel lock for drawer "SYS-AZ"

- Art n° 80101665
  - Consists of a lock with 2 keys and a locking nut.
  - For the safe storage of precious tools. Simple and fast self-assembly
- 



### Anti-slip mat 300 x 400 mm

- For drawer "SYS-AZ" art n° 80590640
  - Anti-slip holding of objects
  - Extremely high anti-slip effect with low material thickness
  - Two side adhesion without sticking
  - Adapts optionally to the base surface
  - Extremely stable, highly tear-proof
-



## REPLACEMENT MADE EASY

We attach great importance to flexibility and a long product life. Therefore, all systemer® components such as lid, handle or catches are easy to replace.

## SPARES



### Systainer³ catch

- For Systainer³ M, L, XXL, Systainer³ lid compartment M, Systainer³ ToolBox
- 12 colors



### Systainer³ Organizer catch

- For Systainer³ Organizer
- 12 colors



### Systainer³ Pin

- For Systainer³ M, L, XXL, Systainer³ Organizer M + L, Systainer³ lid compartment M, Systainer³ ToolBox
- Light grey art n° 83570018
- Anthracite art n° 83570024



### Systainer³ lid handle

- For Systainer³ M, L, XXL, Systainer³ lid compartment M,
- Light grey art n° 83570019
- Anthracite art n° 83570025



### Systainer³ M lid without handle + catch

- For Systainer³ M
- Light grey art n° 83570020



### Systainer³ L lid without handle + catch

- For Systainer³ L
- Light grey art n° 83570021



### Systainer³ front handle

- For Systainer³ heights with front handle 112-187, Systainer³ Organizer, Systainer³ lid compartment M 137+187
- Light grey art n° 83500329
- Anthracite art n° 83500330

## COLORS

	Standard colors	Additional colors
Systainer³ catch	2)  3)	1)  4)  5)  6)  7)  8)  9)  10)  11)  12)
Systainer³ Organizer catch		
Systainer³ Pin	1)	
Systainer³ lid handle		
Systainer³ lid M + L		
Systainer³ front handle		

1) RAL 7035, light grey  
2) HKS 43 K, signal blue  
3) RAL 7016, anthracite

4) RAL 9004, black  
5) RAL 1007, daffodil yellow  
6) RAL 2011, deep orange

7) RAL 3002, carmine red  
8) RAL 5015, sky blue  
9) RAL 5003, sapphire blue

10) RAL 6001, emerald green  
11) HKS 54 K, signal green  
12) RAL 9016, white



## SPARES



### T-Loc catch

- For systainer® T-Loc I-V, MIDI-systainer® T-Loc II + III, systainer T-Loc “SYS-Combi II + III”
- 12 colors



### T-Loc catch

- For MINI-systainer® T-Loc I + III
- 12 colors



### SYS-Sort catch

- For Sortainer T-Loc “SYS-Sort IV / 3”
- 12 colors



### Catches

- For MAXI-systainer®, Drawer-systainer®, Rack-systainer®, systainer® Tool-Box 1 + 2 and systainer® Storage-Box
- 11 colors



### Pin

















































- For systainer® T-Loc I - V lid, MIDI-systainer® T-Loc II + III, systainer® T-Loc “SYS-Combi II + III”
- Light grey art n° 83570102
- Anthracite art n° 83570103



### T-Loc handle

- For systainer® T-Loc I - V, MIDI-systainer® T-Loc II + III, systainer® T-Loc “SYS-Combi II + III” and Sortainer T-Loc “SYS-Sort IV / 3”
- Light grey art n° 83570081
- Anthracite art n° 83570082

## COLORS

	Standard colors	Additional colors
T-Loc catch	 <sup>2)</sup>  <sup>3)</sup>	 <sup>1)</sup>  <sup>4)</sup>  <sup>5)</sup>  <sup>6)</sup>  <sup>7)</sup>  <sup>8)</sup>  <sup>9)</sup>  <sup>10)</sup>  <sup>11)</sup>  <sup>12)</sup>
SYS-Sort catch	 	         
Catches	 	        
Pin	 <sup>1)</sup> 	
T-Loc handle	 	        

- 1) RAL 7035, light grey  
 2) HKS 43 K, signal blue  
 3) RAL 7016, anthracite

- 4) RAL 9004, black  
 5) RAL 1007, daffodil yellow  
 6) RAL 2011, deep orange

- 7) RAL 3002, carmine red  
 8) RAL 5015, sky blue  
 9) RAL 5003, sapphire blue

- 10) RAL 6001, emerald green  
 11) HKS 54 K, signal green  
 12) RAL 9016, white

## SPARES



### T-Loc lid without handle + catch

- For systainer® T-Loc I-V, systainer® T-Loc „SYS-Combi II + III“
- Light grey art n° 83570120



### Systainer³ CART/BASE catch

- Signal blue Art n° 83570026
- Anthracite Art n° 83570027



### Slide for “SYS-CART”, set of 2

- Signal blue art n° 80590811
- Anthracite art n° 80590957



### Sliding rails for “SYS-Roll”, set of 2

- Black art n° 83570144



### Thermal switch for “SYS-PH”

- Art n° 83570133



### Cable with plug for “SYS-PH”

- EU art n° 83570134
- DK art n° 83570135
- CH art n° 83570136
- GB art n° 83570137



### Socket for “SYS-PH”

- TYP F (DE/NL/SE/AT/HU/FI/LT) art n° 83570138
- TYP F (IT/ES) art n° 83570139
- TYP K (DK) art n° 83570140
- TYP J (CH) art n° 83570141
- TYP G (GB) art n° 83570142
- TYP E (FR/BE/CZ/SK/PL) art n° 83570143

## SPARES – MOBILE WORKSHOP



1

**Work surface made of MDF for Mobile Workshop MW 1000 Basic**

- Art n° 80591089
- Dimensions: 445 x 363 mm
- Incl. fastening materials



2

**Work surface made of MDF for table TSB/1-MW 1000**

- Art n° 80591086
- Dimensions: 970 x 445 mm
- Incl. fastening materials



3

**Slide element for Mobile Workshop MW 1000 Basic**

- Art n° 80591088
- 2 pieces
- Incl. fastening materials



4

**Spacer for Mobile Workshop MW 1000 Basic**

- Art n° 80591090
- Set of 2



5

**Foot for Mobile Workshop MW 1000 Basic and table TSB/1-MW 1000**

- Art n° 80591087



6

**Table connector for table TSB/1-MW 1000**

- Art n° 80591085
- Incl. fastening materials

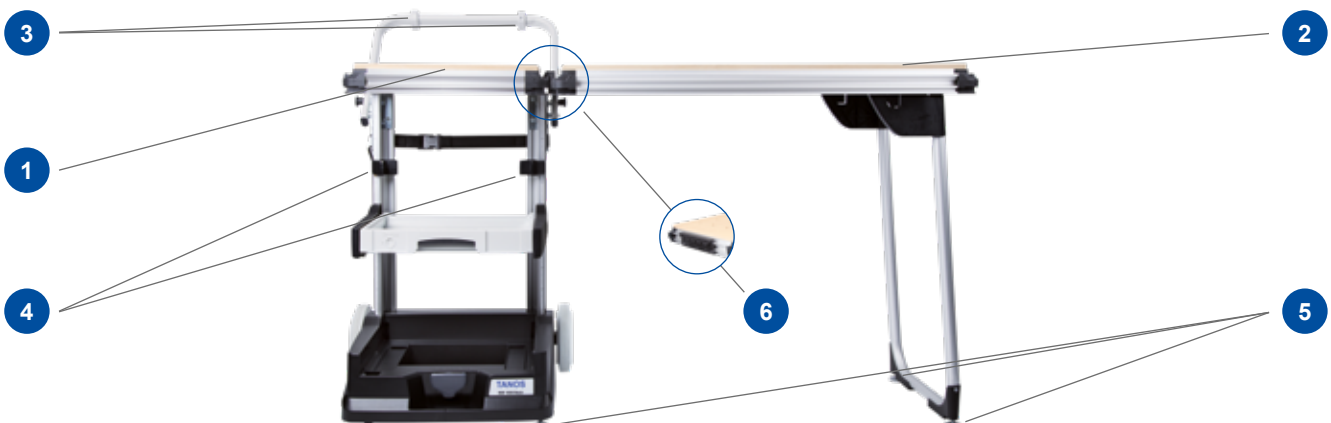

# TANOS

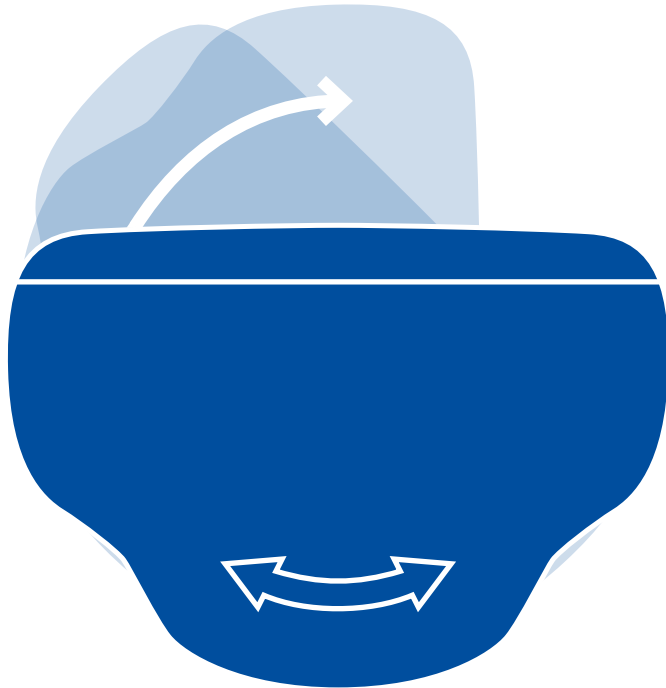

Systainer³



systainer® T-Loc

Illustrations in life size



systainer® CLASSIC-Line

## TANOS GmbH

Pionierstraße 1; D - 89257 Illertissen, Germany  
Phone +49 (0)7303 / 165 302 - 00; Fax +49 (0)7303 / 165 302 - 31  
info@TANOS.de; www.TANOS.de

Issue: 06/2022. We reserve the right to make product modifications, misprints and errors. Please consult the instructions before using any product. All illustrations are non-binding. Decorations and product examples not included in the scope of supply.

Art n° 80002837 | EN