



# DESIGN GUIDE



© Just Swiss

**SIMPLY  
INGENIOUS**

© TheSimplify - Fotolia\_67620900

- Important facts and figures summarized in short
- For simple dimensioning of all SHERPA products
- Enables quick and rational planning



# SHERPA FOR WALLS, CEILING AND SUPPORTING FRAMEWORK

## HOW IT WORKS

SHERPA connectors consist of two aluminium plates, joined friction-locked according to the principle of a classic dovetail connection.

This ingeniously simple system permits safe load absorption in, opposite and across the direction of insertion. Tensile and compressive forces are absorbed with equal ease, and the accommodation of momentary stress is also guaranteed.

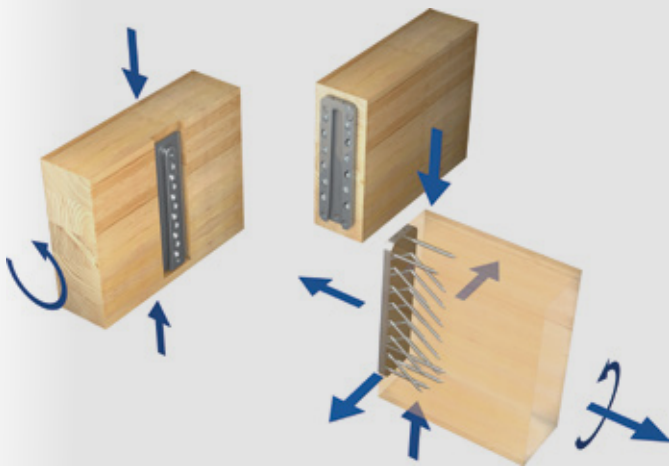

## THE BENEFITS ARE PERFECTLY EVIDENT:

- Security based on a certified system
- Multifunctional in strength and application
- Standardised and simple calculation
- High level of prefabrication
- Rapid assembly

## SUCCESS IN CONSTRUCTION

The mature and tested SHERPA technology permits efficient & competitive planning and execution of demanding tasks throughout the construction industry.

The range of applications stretch from nodal points in timber engineering, connection situations to other building materials such as steel or concrete, through to conservatories, carports and stairs.

The broad product family delivers a tailored, secure and economic solution for any task. The high level of prefabrication and the rapid assembly of these standardised connectors guarantee economic implementation of the most varied projects.



TIMBER ENGINEERING



CARPORTS

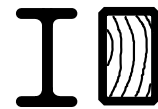

STEEL-WOOD

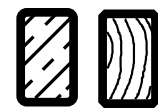

CONCRETE-WOOD

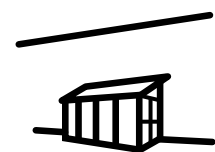

SUNROOMS



STAIRS

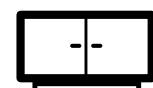

FURNITURE CONSTRUCTION

# INGENIOUS SUPPORT



## CLIENTS

Carpenters

Architects

Trading

Civil engineers

Do-it-yourself

Cabinet makers

ENQUIRY



### Information on ...

- size of component
- quality of wood used
- connection angle
- load values (design)

... is welcome.

SOLUTION



### Recommendations for ...

- the best choice of connectors
- position
- validation
- assembly

... and other aspects

## TECHNICAL SUPPORT

Whether per e-mail, phone or videoconference - SHERPA users are welcome to contact our experienced support team consisting of civil engineers and practitioners at any time. Support ranges from simply inquiries to select the appropriate connector to on-site trainings and talks with inspection engineers within large-scale projects.

Fon +43 3127 41 983 - 311  
office@sherpa-connector.com



DI (FH)  
Josef Kowal

## SHERPA MANUAL

The SHERPA manual provides all relevant data required for standardized connections during planning and implementation stages.

The chapter Models gives further information about operating principles under different loads and stresses. Calculation examples will prove traceability of planning stages.



## ONLINE PRELIMINARY RATING TOOL

The browser-based software can be accessed easily and quickly with mobile devices such as smart phones or personal computers.

The software is simply ingenious and free!

<https://sherpa.ing-tools.de/>

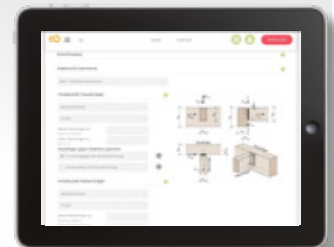

in cooperation with ingtools

## TENDER TEXT

In order to support tendering clients, SHERPA offers detail and comprehensive boilerplates for standard connectors for timber construction.

These texts can be easily and quickly adapted to any given connection situation. Minimum requirements regarding load-bearing capacity and appearances as well as rigidity and fire protection are considered.



## SOFTWARE CONNECTION

In order to support SHERPA users during work preparation and scheduling, all connectors can be downloaded in the usual design and woodwork programs.

The whole SHERPA connector product range is available on SHERPA website for download as 2D or 3D geometrical files.



# NOW EVEN MORE EFFICIENT THANKS TO NEW ETA-12/0067

## EXTENDED LOAD CARRYING CAPACITY OF THE CONNECTORS

The additional screw lengths allow a wider range of applications for the individual connector series.

The more than 70 different SHERPA connectors have been an integral part of efficient timber construction since 2012.

The new technical assessment ETA-12/0067 of 4 June 2018 now provides new solutions and advantages within the framework of the European Construction Products Regulation.

### The new features of the assessment include:

- Unique fire protection solution with and without fire protection laminate
- 6 new connector types of the L-, XL- and XXL-series as an addition
- 5 alternative screw lengths for up to 80 % higher load capacities
- Hardwood connection as an additional standard

## VARIABLE SCREW LENGTHS OF THE SHERPA SERIES M, L, XL AND XXL

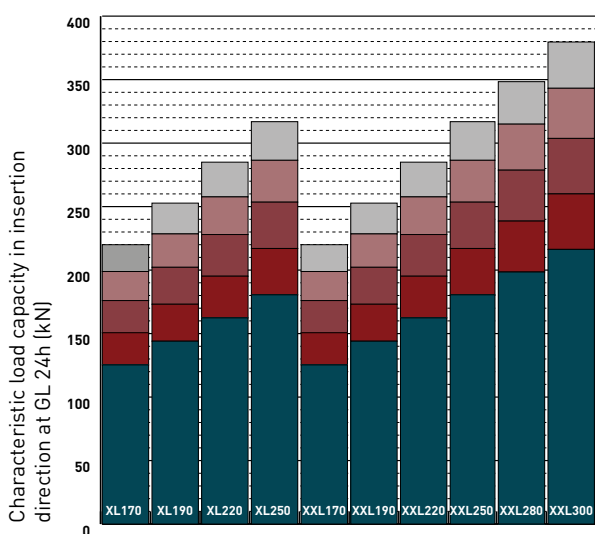
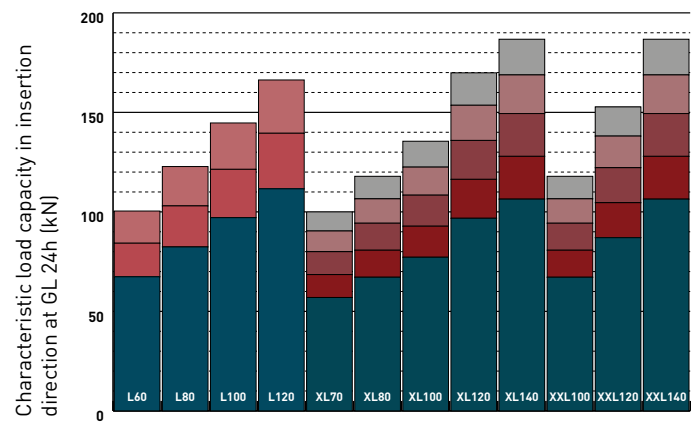
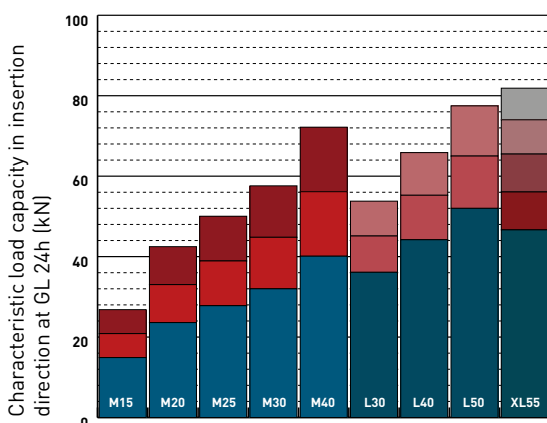

### M-Series

Ø 6,5 [mm]	Length [mm]	$\eta_s$
	105	1,80
	85	1,40
	65 *	1,00

### L-Series

Ø 8,0 [mm]	Length [mm]	$\eta_s$
	140	1,49
	120	1,25
	100 *	1,00

### XL / XXL-Series

Ø 8,0 [mm]	Length [mm]	$\eta_s$
	200	1,25
	180	1,13
	160 *	1,00
	140	0,86
	120	0,71

\* Standard screw length

"Blue": New version of ETA-12/0067 of 4 June 2018.

Carrying capacity in relation to the screw lengths used is calculated as follows:

$$R_{k;s} = \eta_s \cdot R_k$$

$R_k$ ..... Characteristic load-bearing capacity value for standard screw length  
 $R_{k;s}$ ..... Characteristic value for carrying capacity for the screw length used

# STANDARD CHARACTERISTICS OF THE SHERPA SERIES XS TO XXL

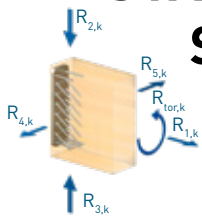

Dimensions			Screws	Minimum cross-section <sup>1)</sup>		charact. carrying capacity (GL 24h)						
mm			mm			kN					kNm	
B	H	L	4,5 x 50	MB	SB	R <sub>1,k</sub>	R <sub>2,k</sub>	R <sub>3,k</sub>	R <sub>45,k</sub>	R <sub>tor,k</sub>		
XS 5	30	50	12	12	50/80	50/80	4,4	6,3	3,76	3,3	61	
XS 10		70		18	50/100	50/100	8,3	11,8		5,2	122	
XS 15		90		21	50/120	50/120	10,1	14,4		6,2	183	
XS 20		110		25	50/140	50/140	13,7	19,5		7,1	256	
S 5	40	50	12	12	50/80	60/80	4,4	6,3	5,67	3,3	69	
S 10		70		18	50/100	60/100	8,3	11,8		5,2	134	
S 15		90		21	50/120	60/120	10,1	14,4		6,2	195	
S 20		110		25	50/140	60/140	13,7	19,5		7,1	268	
M 15	60	90	14	6,5 x 65 <sup>3)</sup>		MB	SB	R <sub>1,k</sub>	R <sub>2,k</sub>	8,95	R <sub>45,k</sub>	R <sub>tor,k</sub>
M 20		110		16	65/120	80/120	10,5	14,9	8,4		283	
M 25		130		20	65/140	80/140	16,6	23,6	10,0		395	
M 30		150		23	65/160	80/160	19,5	27,8	11,7		527	
M 40		170		26	65/180	80/180	22,4	32,0	13,3		678	
L 30	80	150	18	8,0 x 100 <sup>3)</sup>		MB	SB	R <sub>1,k</sub>	R <sub>2,k</sub>	17,5	R <sub>45,k</sub>	R <sub>tor,k</sub>
L 40		170		15	100/180	100/180	25,4	36,1	15,3		839	
L 50		210		18	100/200	100/200	31,0	44,2	18,2		1 090	
L 60		250		21	100/240	100/240	36,5	52,0	21,2		1 529	
L 80		290		25	100/280	100/280	47,3	67,4	24,2		2 052	
L 100		330		29	100/320	100/320	57,9	82,4	27,1		2 643	
L 120		370		33	100/360	100/360	68,2	97,1	30,1		3 309	
XL 55	120	250	20	8,0 x 160 <sup>3)</sup>		MB	SB	R <sub>1,k</sub>	R <sub>2,k</sub>	62,3	R <sub>45,k</sub>	R <sub>tor,k</sub>
XL 70		290		18	160/280	140/280	65,5	80,0	27,6		2 619	
XL 80		330		21	160/320	140/320	80,0	94,3	32,0		3 488	
XL 100		370		24	160/360	140/360	94,3	108,4	36,4		4 421	
XL 120		410		25	160/400	140/400	108,4	135,9	36,4		4 984	
XL 140		450		29	160/440	140/440	135,9	149,4	40,8		6 039	
XL 170		490		32	160/480	140/480	149,4	176,0	45,2		7 204	
XL 190		530		36	160/520	140/520	176,0	202,2	49,6		8 487	
XL 220		570		40	160/560	140/560	202,2	228,0	54,1		9 892	
XL 250		610		44	160/600	140/600	228,0	253,5	58,5		11 416	
XXL 100	140	290	20	8,0 x 160 <sup>3)</sup>		MB	SB	R <sub>1,k</sub>	R <sub>2,k</sub>	62,3	R <sub>45,k</sub>	R <sub>tor,k</sub>
XXL 120		330		22	160/320	160/320	94,3	122,2	32,0		3 610	
XXL 140		370		27	160/360	160/360	122,2	149,4	38,6		4 668	
XXL 170		410		32	160/400	160/400	149,4	176,0	45,2		5 967	
XXL 190		450		37	160/440	160/440	176,0	202,2	51,9		7 410	
XXL 220		490		42	160/480	160/480	202,2	228,0	58,5		9 065	
XXL 250		530		47	160/520	160/520	228,0	253,5	65,1		10 866	
XXL 280		570		52	160/560	160/560	253,5	278,7	71,7		12 883	
XXL 300		610		54	160/600	160/600	278,7	303,7	71,7		14 042	
XXL 300	610	59	160/640	160/640	303,7		78,3	16 296				

<sup>1)</sup> Minimum cross-sections apply for standard screw length if the upper edge of the main and secondary beams are installed flush. HT | Main beam NT | Secondary beam

<sup>2)</sup> For static calculations the characteristics of the respectively valid ETA must be taken into account and depend on the timber quality and the screw length used.

<sup>3)</sup> Alternative screw lengths: Series M: 6.5 x 85, 6.5 x 105, Series L: 8 x 120, 8 x 140, Series XL/XXL: 8 x 120, 8 x 180, 8 x 200

# ASSEMBLY INSTRUCTION XS - XXL SERIES

Taking the respective edge distances into account, the connector plate with the larger number of bore holes – the groove plate – is always screwed to the grain-cut timber.

## VISIBLE CONNECTION

The connector plates are face-mounted to the main and secondary members and therefore visible.

To ensure a proper fit, it is recommended to pre-drill the positioning screws. The diameter of the pilot hole may not exceed the core diameter of the screw.

Serie	min. secondary beam width in mm
M	80
L	100
XL	140
XXL	160

## CONCEALED CONNECTION

OPTION 1



### RECESSING IN MAIN BEAM

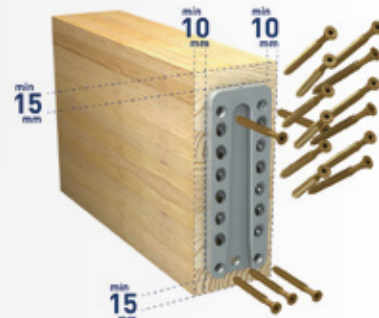

### Recommended screw torque

XS - S	$M_T = 1,5 \text{ Nm}$
M	$M_T = 2,5 \text{ Nm}$
L	$M_T = 5,0 \text{ Nm}$
XL - XXL	$M_T = 10,0 \text{ Nm}$

Min.: Screw head is in contact with counter sink

### Housing depth

XS- to M- connectors, the housing has to be 1 mm less deep than the total thickness of the installed connector.  
L- to XXL-connectors, the housing has to be 3mm less deep than the total thickness of the installed connector.

OPTION 2



### RECESSING IN SECONDARY BEAM

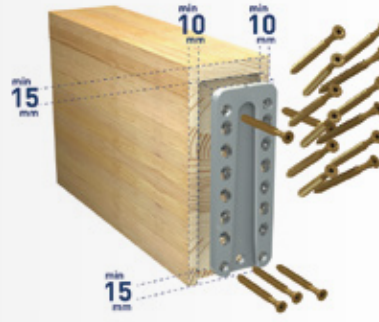

M	min. beam height in mm		
	6.5 x 65*	6.5 x 85	6.5 x 105
M 15	120	160	180
M 20	140	180	200
M 25	160	200	220
M 30	180	220	240
M 40	200	240	260

L	min. beam height in mm		
	8 x 100*	8 x 120	8 x 140
L 30	180	220	240
L 40	200	240	260
L 50	240	280	300
L 60	280	320	340
L 80	320	360	380
L 100	360	400	420
L 120	400	440	460

XL	min. beam height in mm	
	8 x 120/140 8 x 160*/180	8 x 200
XL 55	280	300
XL 70	320	340
XL 80	360	380
XL 100	400	420
XL 120	440	460
XL 140	480	500
XL 170	520	540
XL 190	560	580
XL 220	600	620
XL 250	640	660

XXL	min. beam height in mm	
	8 x 120/140 8 x 160*/180	8 x 200
XXL 100	320	360
XXL 120	360	400
XXL 140	400	440
XXL 170	440	480
XXL 190	480	520
XXL 220	520	560
XXL 250	560	600
XXL 280	600	640
XXL 300	640	680

\* "Blue": New version of ETA-12/0067 of 4 June 2018.

\* Standard screw length

The minimum cross-section width of each series for the secondary beam is retained even with longer bolts.

# FIRE PROTECTION

Since 2012, we have developed new solutions for practical fire protection for our SHERPA connectors as part of numerous tests.

Specifically, we can guarantee fire resistance R30 (single layer) and R60 (double layer) for the concealed and visible connection variant. The Fire Stop 2.5 is used in one or two layers for the visible, screwed-on connection. The fire protection laminate swells at 150°C and protects the aluminium of the connector plates from direct exposure to high temperatures.

If the connection is milled into the main or secondary beam, the joint width may be up to 5 mm without additional protective measures being required.

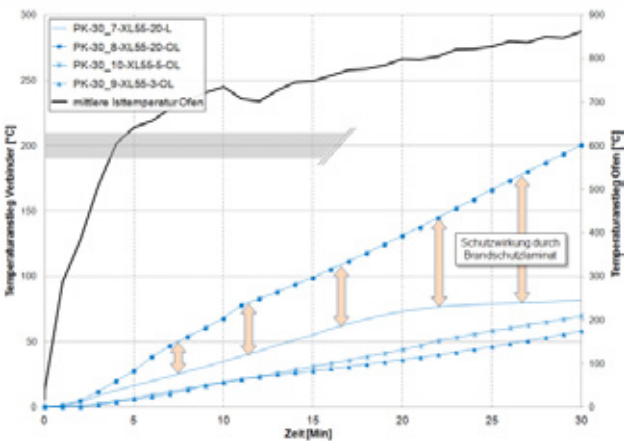

The fire protection laminate is applied to the wood surface around the SHERPA connector and swells at 150°C.



The activated laminate protects the SHERPA from direct exposure to high temperatures.

## EXTRACT FROM THE ETA-12/0067 OF 4 JUNE 2018

**Classification R30** for beam hanger type M, L, XL and XXL in solid wood and glued laminated timber

- milled into the wood-based members with a **joint width  $\leq 5$  mm or**
- with a joint provided with a **min. 20 mm** wide position of the **SHERPA Fire Stop**,
- and an increase of the minimum cross section according to Table 1,
- valid for a conversion factor  $n = 0.44$  according to EN 1995-1-2.

SHERPA Series	Increase of edge distance on all sides exposed to fire $\Delta a_1 = \Delta a_3$	Increase of edge distances	
		Each side $\Delta a_1$	Bottom side $\Delta a_3$
	mm	mm	mm
M	+20	+15	+30
L	+15	+12,5	+17,5
XL	+12,5	+10	+20
XXL			

Table 1: Increase of the minimum cross section for classification R30

**Classification R60** for beam hanger type M, L, XL and XXL in solid wood and glued laminated timber

- milled into the wood-based members with a **joint width  $\leq 5$  mm or**
- with a joint provided with a **min. 40 mm** (optionally 2 x 20 mm) wide position of the **SHERPA Fire Stop**,
- and an increase of the minimum cross section according to Table 2,
- valid for a conversion factor  $n = 0.44$  according to EN 1995-1-2

SHERPA Series	Increase of edge distance on all sides exposed to fire $\Delta a_1 = \Delta a_3$	Increase of edge distances	
		Each side $\Delta a_1$	Bottom side $\Delta a_3$
	mm	mm	mm
M	+45	+50	+40
L	+40	+40	
XL			
XXL			+35

Table 2: Increase of the minimum cross section for classification R60





# ASSEMBLY INSTRUCTION CS SERIES

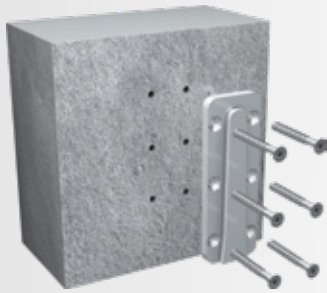

## CONNECTION TO REINFORCED CONCRETE

The bore holes must be vertical to the assembly level and sufficiently deep. The assembly instruction of the used fastener needs to be respected. The following through-holes or counterbores for concrete screws or metal splay dowels were provided as follows :

M.....	7,9 / 15,4 mm	e.g. Fischer FBS II 6 x 60/5 SK
L.....	11,0 / 21,0 mm	e.g. Fischer FBS II 8 x 80/30/15 SK
XL.....	11,0 / 21,0 mm	e.g. Fischer FBS II 8 x 80/30/15 SK
XL.....	14,0 / 26,0 mm	e.g. Fischer FH II 12/15 SK
XL.....	14,0 / 26,0 mm	e.g. Fischer FBS II 10 x 80/25/15 SK
XXL.....	11,0 / 21,0 mm	e.g. Fischer FBS II 8 x 80/30/15 SK



## CONNECTION TO STEEL

The boreholes need to be created according to the state-of-the-art in steel constructions. With regards to the connection to elements in steel it needs to be made sure that there is sufficient space for the positioning of screw-nuts. The following steel bolts can be used:

M.....	7,9 / 15,4 mm	DIN 7991	4.6 / 8.8 SK	M 6
L.....	11,0 / 21,0 mm	DIN 7991	4.6 / 8.8 SK	M 10
XL.....	11,0 / 21,0 mm	DIN 7991	4.6 / 8.8 SK	M 10
XXL.....	11,0 / 21,0 mm	DIN 7991	4.6 / 8.8 SK	M 10

## HARDWOOD

Due to the increasing use of hardwood for load-bearing components, we have looked at the effects on our SHERPA connector system and in particular on the special screws. Screw-in attempts were carried out at different screw-in angles, and load-bearing capacity tests have been performed.

Based on this, the practical screw lengths and the associated load carrying capacity values are now available for the dimensioning of connections of various hardwoods and materials made from them.



Photos above: Experimental setup at the Lignum Test Center of the TU Graz with hardwood

M	Hardwood		L	Hardwood		XL	Hardwood 8 x 120 mm		XXL	Hardwood 8 x 120 mm	
	6.5 x 65 mm	6.5 x 85 mm		8 x 100 mm	8 x 120 mm		SHERPA	SCHMID		SHERPA	SCHMID
M 15	34,3	48,0	L 30	83,0	103,8	XL 55	107,3	116,6	XXL 100	154,5	167,9
M 20	54,3	76,0	L 40	101,7	127,1	XL 70	131,1	142,4	XXL 120	200,2	217,6
M 25	63,9	89,5	L 50	119,6	149,5	XL 80	154,5	167,9	XXL 140	244,7	266,0
M 30	73,6	103,0	L 60	155,0	193,8	XL 100	177,6	193,0	XXL 170	288,3	313,4
M 40	92,2	129,1	L 80	189,5	236,9	XL 120	222,6	242,0	XXL 190	331,2	360,0
			L 100	223,3	279,2	XL 140	244,7	266,0	XXL 220	373,5	406,0
			L 120	256,7	320,9	XL 170	288,3	313,4	XXL 250	415,3	451,4
						XL 190	331,2	360,0	XXL 280	456,5	496,2
						XL 220	373,5	406,0	XXL 300	497,5	540,8
						XL 250	415,3	451,4			

"Blue": New version of ETA-12/0067 of 4 June 2018.

The oblique screws may be screwed into hardwood without pre-drilling. The torque screws must be pre-drilled.

## REDUCTION FACTOR $n_2$ WITH ECCENTRIC STRESS

$$R'_{2,k} = n_2 \cdot R_{2,k}$$

$R'_{2,k}$ ..... Characteristic carrying capacity value with eccentric stress in the insertion direction

$R_{2,k}$ ..... Characteristic carrying capacity value with central stress in the insertion direction

		Width of the main beam in mm									
		60	80	100	120	140	160	180	200	220	240
$e^{11}$ [mm]		36	46	56	66	76	86	96	106	116	126
XS/S 5		0,795	0,688	0,596	0,520	0,459	0,410	0,370	0,336	0,308	0,284
XS/S 10		0,622	0,482	0,388	0,324	0,277	0,242	0,215	0,193	0,175	0,160
XS/S 15		0,711	0,546	0,434	0,357	0,303	0,262	0,231	0,207	0,187	0,171
XS/S 20		0,792	0,607	0,475	0,387	0,325	0,279	0,245	0,218	0,196	0,178
		Width of the main beam in mm									
		80	100	120	140	160	180	200	220	240	260
$e^{11}$ [mm]		47	57	67	77	87	97	107	117	127	137
M 15		0,736	0,626	0,536	0,465	0,410	0,365	0,329	0,299	0,274	0,253
M 20		0,721	0,599	0,505	0,433	0,378	0,335	0,300	0,272	0,248	0,229
M 25		0,737	0,605	0,503	0,428	0,370	0,326	0,291	0,263	0,239	0,220
M 30		0,767	0,623	0,513	0,432	0,371	0,325	0,288	0,259	0,235	0,216
M 40		0,807	0,652	0,531	0,443	0,378	0,328	0,290	0,260	0,235	0,215
		Width of the main beam in mm									
		100	120	140	160	180	200	220	240	260	280
$e^{11}$ [mm]		59	69	79	89	99	109	119	129	139	149
L 30		0,667	0,567	0,488	0,427	0,378	0,339	0,307	0,280	0,258	0,239
L 40		0,685	0,578	0,494	0,429	0,378	0,337	0,304	0,277	0,254	0,235
L 50		0,824	0,708	0,606	0,523	0,458	0,405	0,363	0,329	0,300	0,276
L 60		0,876	0,752	0,636	0,542	0,468	0,410	0,365	0,328	0,297	0,272
L 80		0,934	0,816	0,687	0,578	0,493	0,427	0,376	0,335	0,302	0,275
L 100		0,979	0,892	0,760	0,635	0,534	0,458	0,398	0,352	0,315	0,285
L 120		0,998	0,954	0,839	0,703	0,585	0,495	0,426	0,372	0,330	0,297
		Width of the main beam in mm									
		120	140	160	180	200	220	240	260	280	300
$e^{11}$ [mm]		70	80	90	100	110	120	130	140	150	160
XL 55		0,938	0,903	0,863	0,819	0,774	0,730	0,687	0,647	0,610	0,576
XL 70		0,927	0,881	0,827	0,771	0,717	0,665	0,618	0,575	0,537	0,503
XL 80		0,934	0,882	0,822	0,758	0,697	0,641	0,590	0,545	0,505	0,470
XL 100		0,983	0,958	0,921	0,874	0,821	0,766	0,712	0,661	0,615	0,573
XL 120		0,989	0,965	0,927	0,875	0,816	0,755	0,697	0,642	0,593	0,549
XL 140		0,995	0,977	0,941	0,889	0,827	0,762	0,698	0,640	0,587	0,541
XL 170		0,999	0,988	0,960	0,912	0,849	0,780	0,712	0,649	0,593	0,544
XL 190		1,000	0,996	0,978	0,938	0,879	0,809	0,737	0,669	0,608	0,555
XL 220		1,000	1,000	0,991	0,963	0,912	0,844	0,769	0,696	0,630	0,572
XL 250		1,000	1,000	0,998	0,982	0,943	0,881	0,806	0,729	0,658	0,595
XXL 100		0,980	0,959	0,928	0,890	0,846	0,800	0,753	0,708	0,665	0,625
XXL 120		0,983	0,959	0,923	0,878	0,828	0,775	0,722	0,673	0,627	0,586
XXL 140		0,989	0,967	0,932	0,885	0,830	0,772	0,716	0,663	0,615	0,571
XXL 170		0,995	0,979	0,948	0,902	0,846	0,785	0,725	0,668	0,617	0,570
XXL 190		0,998	0,988	0,962	0,918	0,860	0,796	0,731	0,669	0,614	0,564
XXL 220		1,000	0,996	0,978	0,940	0,884	0,818	0,749	0,683	0,623	0,570
XXL 250		1,000	0,999	0,990	0,962	0,913	0,848	0,776	0,705	0,640	0,583
XXL 280		1,000	1,000	0,998	0,986	0,958	0,911	0,851	0,785	0,719	0,658
XXL 300		1,000	1,000	1,000	0,995	0,976	0,938	0,881	0,814	0,745	0,679

Intermediate values must be linearly interpolated!

$^{11} e = b_{MB}/2 + d/2$        $b_{MB}$ ... Width of the main beam in mm       $d$ ... Thickness of the connector

# FEATURES FOR THE SHERPA EFCON

The main purpose of the SHERPA EFCON facade connector is to fix timber constructions to a load-bearing subbase such as exterior walls of new or existing buildings. It enables mounting and fixing of prefab facade elements in timber construction for building ecologically high-grade and energy efficient building envelopes.

The SHERPA EFCON facade connector consists of two components. This connector enables fixing and adjusting facade elements in a friction-type and precise manner. Horizontal and vertical wind forces, dead load and earthquake loads, if any, can be diverted to the substructure.

		Rated values for carrying capability in kN with C24 <sup>1) 2)</sup>					
		R <sub>1,d</sub> compression	R <sub>1,d</sub> tension	R <sub>2,d</sub>			
k <sub>mod</sub>		1,0	1,0	0,6	0,7	0,8	0,9
screw lengths	140	22,4	16,9	17,7	20,6	22,8	22,8
	160		20,2	20,6	22,8		
	180			22,8		22,8	
	200		22,8				
Failure of steel elements							

<sup>1)</sup>  $y_M = 1,3$

<sup>2)</sup> The connection to the supporting structure must be proven separately. Evidence for combined stress is additionally necessary.

		Rated values for carrying capability in kN with C24 <sup>2) 3)</sup>					
		R <sub>1,d</sub> compression	R <sub>1,d</sub> tension	R <sub>2,d</sub>			
k <sub>mod</sub>		1,0	1,0	0,6	0,7	0,8	0,9
Screw lengths	140	27,2	20,2	21,8	22,8	22,8	22,8
	160			22,8			
	180				22,8		
	200			22,8			
Failure of steel elements							

<sup>3)</sup>  $y_M = 1,25$

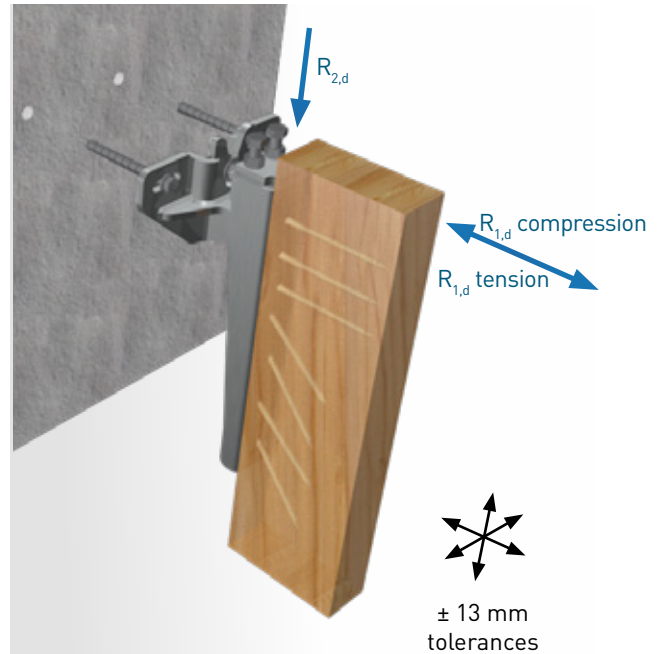

EFCON component 1 for supporting structure	
Dimensions (b/h/l)	210 / 135 / 95 mm
Drill holes	2x elongated hole 13,2 x 40 mm
Fasteners	2 pcs. expansion anchor or screw anchor bolts or injection anchor
Material	S235 JR-Fe/Zn12/C



EFCON component 2 for facade element	
Dimensions (b/h/l)	60 / 365 / 54 mm
Fasteners metal	1 pc. hexagon screw <sup>4)</sup> M12x1.5x70 8.8 as per MBN 10105 incl. nut with flange M12x1.5 as per MBN 13023
Height adjustment metal	2 pcs. hexagon screw <sup>4)</sup> M12 8.8 as per EN ISO 4017 incl. counter nut M12 as per EN ISO 4032
Fasteners wood	4 pcs. c 45° 7 pcs. special screws 8x 120/140/160/180



<sup>4)</sup> width across flat AF 18

## ASSEMBLY INSTRUCTIONS

- According to the substructure, component 1 is fixed with screw anchors, expansion anchors or injection anchors to the load-bearing exterior wall or ceiling. The „ears“ of component 1 serve as guiding aid for positioning the flange head screw of component 2 when hanging it up.
- In the factory, component 2 on the facade element is fixed to the timber frame construction rack by means of three horizontal and four 45° slanted, fully threaded screws. The prefab facade elements are hung by connecting the two components.
- The vertical adjusting screws and horizontal flange head screw enable setting the right position in two directions. The oblong holes of component 1 enable positioning in the 3rd direction. Due to the more than 13 mm tolerance in the 3 directions, roughness and imperfections of the substructure could be compensated for.

# FEATURES FOR THE SHERPA POWER BASE

The below-specified load-bearing capacities are based on ETA-15/0540 as issued by the Austrian Institute of Building Technology on 07 October 2015. Dimensional specifications are provided in the assembly instructions. The specified values refer to service classes 1 and 2 according to EN 1995-1-1. The power base product is intended for use with low to medium corrosive load according to EN ISO 12944-2.

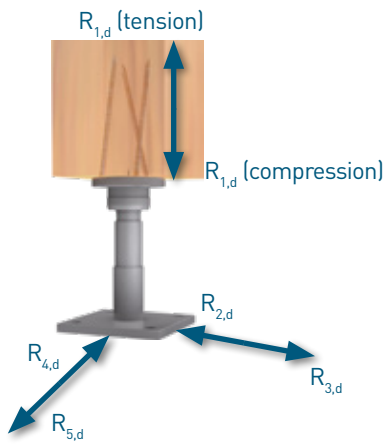

## EXPLANATION OF THE DENOMINATION

**PB** PB - Power Base

**L** M - adjustment area 90 bis 130 mm  
L - adjustment area 150 bis 200 mm  
XL - adjustment area 200 bis 300 mm

**130** e.g.: **130** = max. rated value of load-bearing capacity kN

**C** C - "Cone" - divisible and adjustable under full load  
F - "Flange" - adjustable under full load

## EXAMPLE

**„PB L 130 C“**

## VARIANTS FOR EMBEDDING IN CONCRETE ALSO AVAILABLE

Power Base C Plus and Top



### Rated values for carrying capability in kN with C24

$k_{mod}$	$R_{1,d}$ compression					$R_{1,d;160}$ tension		$R_{1,d;180}$ tension		$R_{23,d}$ and $R_{45,d}$				
	0,6	0,7	0,8	0,9	1,0	0,9	1,0	0,9	1,0	0,6	0,7	0,8	0,9	1,0
M 125 F	70,2	81,8	93,5	105,2	116,9	22,6	25,1	27,8	30,2	2,03				
L 125 F	70,2	81,8	93,5	105,2	116,9									
XL 95 F	70,2	81,8	93,5	95,0	95,0									
L 130 C	70,2	81,8	93,5	105,2	116,9				30,9	1,98	2,30	2,63	2,96	3,29
L 140 C	85,5	99,8	114,0	128,3	138,0					2,43	2,83	3,24	3,64	4,05
XL 120 C	70,2	81,8	93,5	105,2	116,9					0,99	1,16	1,32	1,49	1,65
XL 140 C	85,5	99,8	114,0	128,3	138,0					2,43	2,83	3,24	3,64	4,05

ATTENTION: The specified values do not factor in a buckling of the column!

Failure of steel elements

L 130 C Plus see L 130 C if connection depth tube min. 160 mm  
L 120 C Top see L 120 C if embedment depth threaded rod min. 160 mm  
L 130 C Top see L 130 C if embedment depth threaded rod min. 160 mm

### Rated values for carrying capability in kN with GL 24h

$k_{mod}$	$R_{1,d}$ compression					$R_{1,d;160}$ tension		$R_{1,d;180}$ tension		$R_{23,d}$ and $R_{45,d}$				
	0,6	0,7	0,8	0,9	1,0	0,9	1,0	0,9	1,0	0,6	0,7	0,8	0,9	1,0
M 125 F	83,4	97,3	111,2	125,0	125,0	25,1	27,9	30,2	30,2	2,03				
L 125 F	83,4	97,3	111,2	125,1	129,0									
XL 95 F	83,4	95,0	95,0	95,0	95,0									
L 130 C	83,4	97,3	111,2	125,1	129,0			30,9	34,3	2,19	2,56	2,93	3,29	3,66
L 140 C	101,7	118,6	135,5	138,0	138,0					2,70	3,15	3,60	4,04	4,48
XL 120 C	83,4	97,3	111,2	120,0	120,0					1,10	1,29	1,47	1,65	1,84
XL 140 C	101,7	118,6	135,5	138,0	138,0					2,70	3,15	3,60	4,04	4,48

ATTENTION: The specified values do not factor in a buckling of the column!

Failure of steel elements

L 130 C Plus see L 130 C if connection depth tube min. 160 mm  
L 120 C Top see L 120 C if embedment depth threaded rod min. 160 mm  
L 130 C Top see L 130 C if embedment depth threaded rod min. 160 mm

# ASSEMBLY INSTRUCTIONS SHERPA POWER BASE

## GENERALLY

The SHERPA Power Base C & F with a centre point and angular screw connection facilitates easy and precise assembly. The connection is suitable for supports made of solid wood and glued-laminated timber. The screws are placed such that they are invisible and weatherproof.

Contrary to Power Base F, head plate of type C can be screwed off when mounted on pillar.

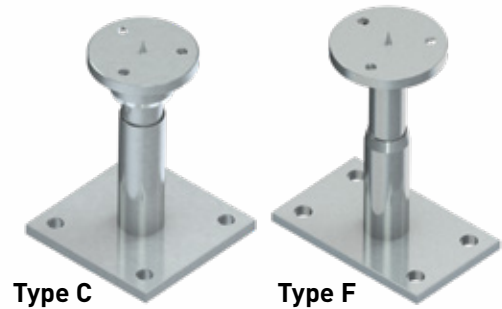

## STEP 1



### Power Base C - End plate visible / invisible

The end plate should be centered on the face and secured with three SHERPA special screws 8 x 160 or 8 x 180 mm at a 25° angle.

Retracting the end plate into the support improves the protection of the structure of the wood (t= 12 mm / Ø 96 or Ø 106 mm).



### Power Base F - End plate visible / invisible

The end plate should be centered on the face and secured with three SHERPA special screws 8 x 160 or 8 x 180 mm at a 25° angle.

Retracting the end plate into the support improves the protection of the structure of the wood (t= 20 mm / Ø 96 mm).

## STEP 2

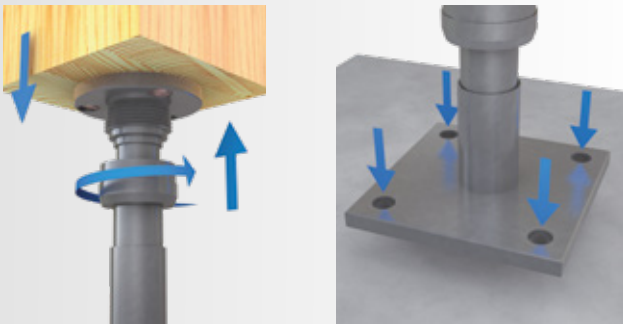

## ASSEMBLY AND ANCHORING

The cone is used to place the end plate of the **Power Base C** accurately on the sub-structure. The joining of the two parts takes place with the coupling nut (open-end wrench 55 mm).

The connection between head plate and foundation of the **Power Base F** is carried out via a flange ring and three socket screws.

Disassembling is possible but not compulsory.

The vibrating plate compactor is anchored either via four expansion anchor, epoxy capsule anchor bolts or via screw anchor bolts.

## STEP 3

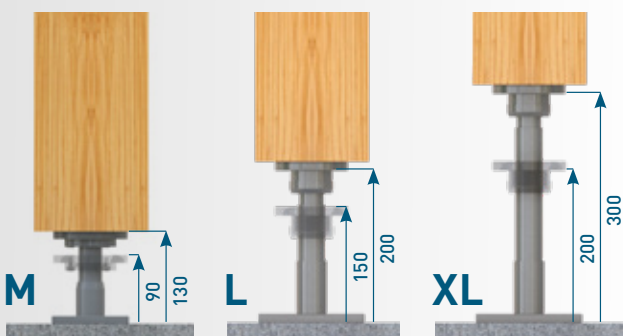

## INFINITELY VARIABLE HEIGHT SETTING

Manufacturing tolerances and settlements in the building can be adjusted even when under load.

open-end wrench:

Power Base C ..... SW 32 resp. 36 mm  
Power Base F ..... SW 26 mm

Possible height settings are:

M ..... 90 - 130 mm  
L ..... 150 - 200 mm  
XL ..... 200 - 300 mm

# FEATURES FOR THE SHERPA CLT CONNECTOR



The SHERPA CLT connector is a coupling element for angle joints, t-joints and longitudinal joints, wall to ceiling connections, as well as ceiling joints.

Optimised for three-layer and five-layer cross-laminated timber elements, the SHERPA CLT connector can be mounted flush in solid wood or glulam already in the preinstallation phase, enabling ready-for-installation delivery to the construction site.

The CLT connector must be milled flush into cross laminated timber or glulam. The load capacity according to ETA can only be guaranteed when using SHERPA special screws.

## GEOMETRY

CLT connector	
Dimensions	18 x 40 x 110 mm
Connecting material	8 pcs. 8,0 x 100 / 120 / 140 mm 2 pcs. 6,5 x 65 mm

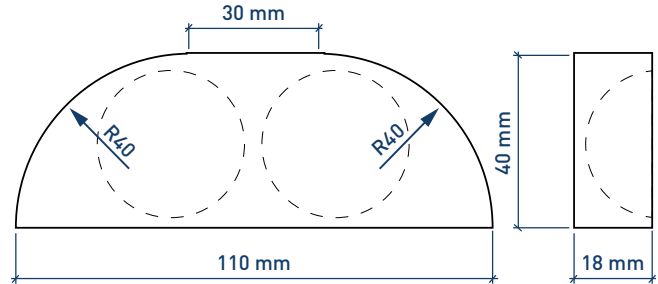

## TECHNICAL DATA

Configuration			Characteristic value <sup>1)</sup>		
			Interlayer ≤ 12 mm	Compriband ≤ 2 mm	
Normal forces	Carrying capability	$R_{1,k}$	18,80 <sup>2)</sup>	kN	
	Stiffness	$K_{ser}$	9.750	N/mm	
Shear force on the surface	Carrying capability	$R_{2,k}$	10,00 <sup>2)</sup>	kN	
	Stiffness	$K_{ser}$	3.300	N/mm	
Shear force from the surface (positive)	Carrying capability	$R_{3,k} (+)$	16,00 <sup>2)</sup>	16,50 <sup>2)</sup>	kN
	Stiffness	$K_{ser}$	3.600	N/mm	
Shear force from the surface (negative)	Carrying capability	$R_{3,k} (-)$	5,30	7,00	kN
	Stiffness	$K_{ser}$	870	1.000	N/mm

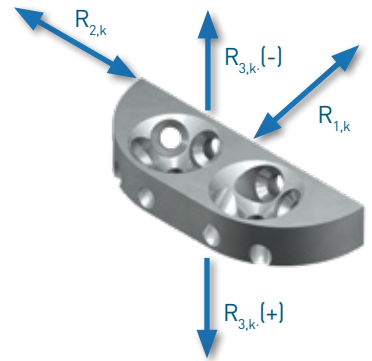

<sup>1)</sup> ETA 18/0083

<sup>2)</sup> screw  $l = 120$  mm:  $n_s = 1,22$

screw  $l = 140$  mm:  $n_s = 1,44$

$R'_k = n_s \cdot R_k$

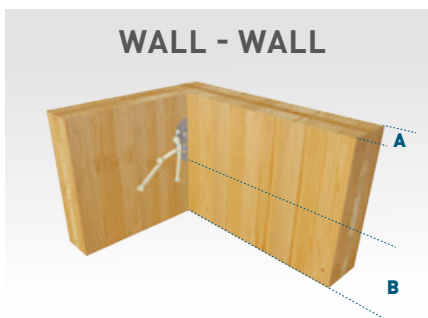

WALL - WALL

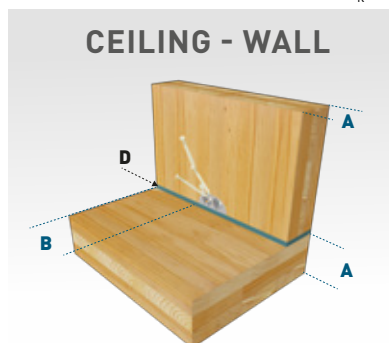

CEILING - WALL

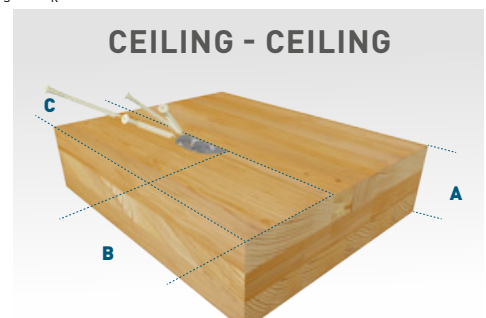

CEILING - CEILING

**A** material thickness: 80 bis 160 mm; > 120 mm: flush milling or install both-sided

**B** edge distance: min. 250 mm

**C** min. 100 mm

**D** Interlayer (e.g. Regufoam): max. 12 mm | Compression hardness: min. 0,2 N/mm<sup>2</sup> | Static elasticity modulus: min. 1,0 N/mm<sup>2</sup>

## INSTALLATION INSTRUCTIONS

- Milling: 18 mm into solid wood or glulam
- Max. distance between the CLT connectors:  $e_{max} = 2$  m
- 2 pcs. special screws 6.5 x 65
- 4 pcs. special screws 8.0 x 100 / 120 / 140 (fix to solid wood / glulam)
- 4 pcs. special screws 8.0 x 100 / 120 / 140 (mount on the second element)

# SOUND PROTECTION WITH SHERPA Regufoam

With SHERPA Regufoam, the SHERPA product range is being extended by sound protection de-coupling bearings for solid timber (BSP boards) and nogging piece structures.

## DESCRIPTION OF MATERIAL OF THE SOUNDPROOF BEARINGS

Regufoam is a waterproof, rot-proof and mixed cellular polyurethane foam produced in twelve different strength levels. These various degrees of hardness are distinguished by colour. At the standard thicknesses of 12.5 and 25 mm a wide range of bearing frequencies can be achieved up to 8 Hertz.

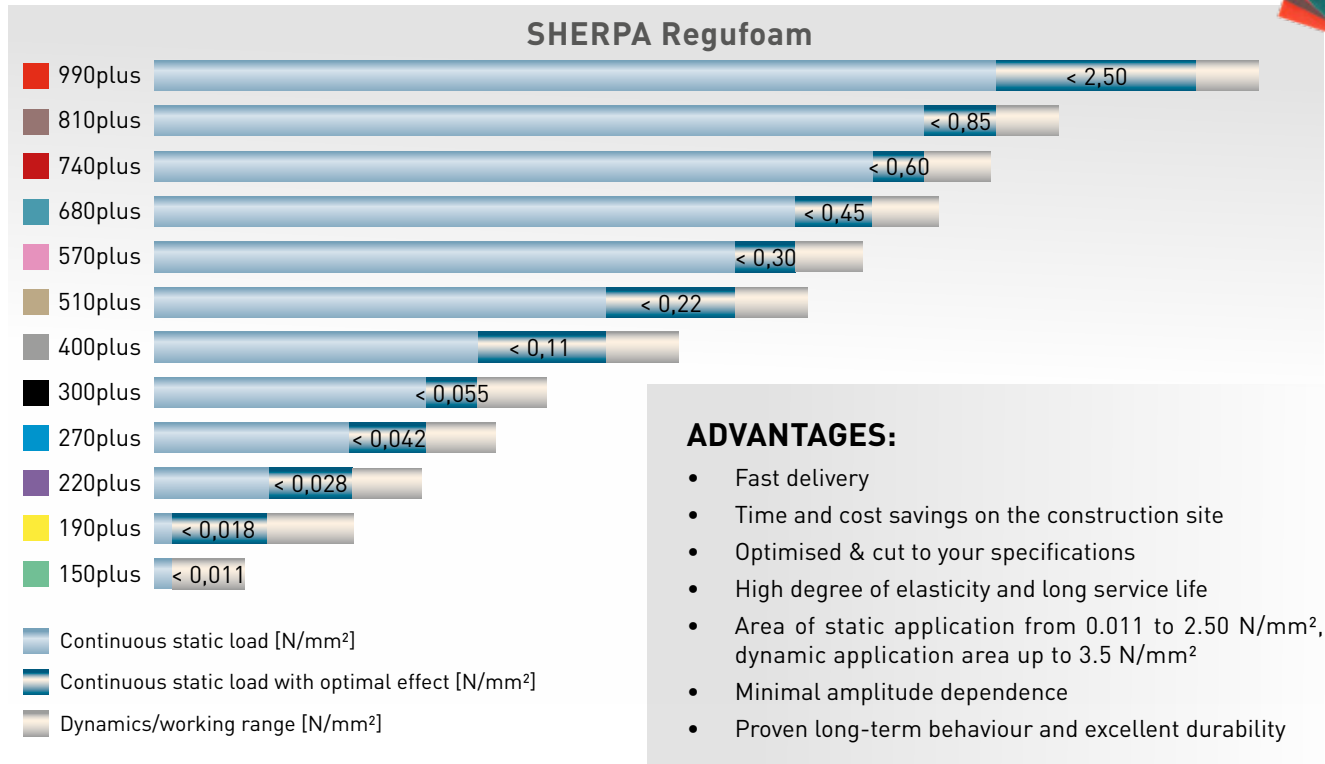

The loads accepted revolve around a sample object. Every construction plan should be preceded by computation by a building physicist/statistician!

## bi-Trapez Bearing

Bi-trapezoidal bearings insulate structure-borne sound and vibrations to a major extent. They are made of quality-monitored elastomer on the basis of the synthetic rubber ethylene-propylene-dien-mixed polymer (EPDM).

### ADVANTAGES:

- Simple processing
- Allows the absorption of high loads
- Parabolic load distribution
- Static range of application (optimum) from 2.5 to 15 N/mm<sup>2</sup>
- High vibration and structure-borne sound insulating values



Dimensioning for bearing class 2 in accordance with DIN 4141 Part 3				
Bearing thickness t	5 mm	10 mm	15 mm	20 mm
Permissible mean compressive stress perm. $\sigma_m$ [N/mm <sup>2</sup> ]	15	10	7	5
Existing bearing spring deflection at perm. $\sigma$ exist. $\Delta t$ [mm]	2,2	4,5	7	9,5
Permissible horizontal shear strain perm. u [mm]	2	4	5,5	8

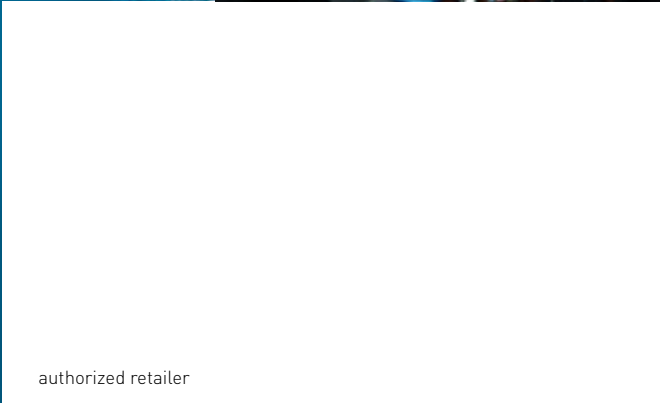

authorized retailer

SHERPA Connection Systems GmbH  
Badl 31  
A-8130 Frohnleiten

SHERPA-HOTLINE International:  
Service +43 3127 41 983  
Technical Support: DW 311

## THE ADVANTAGES ARE CLEAR:

---

SAFETY THROUGH AN  
APPROVED SYSTEM

---

MULTIFUNCTIONAL IN  
STRENGTH AND USE

---

STANDARDIZED AND  
SIMPLE EVALUATION

---

A HIGH DEGREE OF  
PRE-FABRICATION

---

QUICK ASSEMBLY

office@sherpa-connector.com  
www.sherpa-connector.com

www.facebook.com/SHERPACconnector  
www.instagram.com/SHERPACconnector



Website >>



**SHERPA**